

Quick Start

- 1 Set the front panel switches to the following positions:

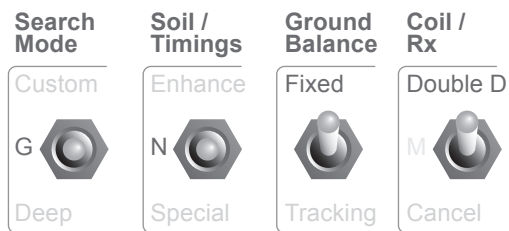

- 2 Push and release the On/Off switch on the rear control panel (pg. 25).
- 3 Turn the Threshold (pg. 34) control clockwise until a hum is audible through the headphones.
- 4 Raise the coil off the ground and Press the Auto Tune (pg. 33) button to reduce electrical interference. The tuning process takes approximately 60 seconds. Do not move the coil or pass metal objects near the coil during the tuning process.
- 5 Whilst lowering and raising the coil between 25mm and 100mm (1" and 4") from the ground, change the Ground Balance switch to Tracking (pg. 40). Any variations in the Threshold will smooth out within 3–5 seconds.
- 6 Adjust the Threshold (pg. 34) to a very faint but still audible level. It should be smooth with only minor fluctuations.

You are now ready to start searching!



Ground Balance

Fixed



Tracking



GPX-4500 Instruction Manual





Minelab is always interested in your opinions. If you have any questions or comments regarding the GPX-4500 or any other Minelab product, please feel free to contact us via your local Authorised Minelab dealer, or write to us:

Minelab Electronics Pty Ltd

PO Box 537, Torrensville Plaza
Adelaide, South Australia, 5031

Australia

Tel: +61 (0) 8 8238 0888

Fax: +61 (0) 8 8238 0890

Email: minelab@minelab.com.au



Minelab International Ltd

Laragh, Bandon

Co. Cork

Ireland

Tel: +353 (0) 23 52101

Fax: +353 (0) 23 52106

Email: minelab@minelab.ie



Minelab USA Inc

871 Grier Drive, Suite B1
Las Vegas, Nevada, 89119

USA

Tel: +1 702 891 8809

Fax: +1 702 891 8810

Email: info@minelabusa.com

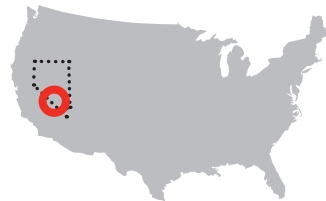

For further product information
and detecting tips, refer to:

WWW.MINELAB.COM

The World Leader in Metal Sensing Technology

From our origins in 1985, Minelab have specialised in advanced electronic technologies. Our competitive advantage was created almost immediately with a highly competent and innovative Research and Development team, inspired by the genius of Mr Bruce Candy.

This commitment to innovation has enabled us to successfully market feature packed Consumer coin and treasure detectors enjoyed by hobbyists worldwide as well as high quality gold detectors used by both professionals and amateurs. Minelab's advanced technology is also incorporated in detection equipment designed for military and humanitarian de-mining projects throughout the world.

Today Minelab has manufacturing, distribution and customer service operations in Australia, Europe and the United States, and is an ISO 9001 Quality Endorsed Company. ISO 9001 is a worldwide quality standard certification that ensures the highest level of product quality for our customers.



Working for a Cleaner, Greener Future

For Consumers within the European Union: Do not dispose of this equipment in general household waste.

The crossed wheeled bin symbol on this equipment indicates this unit should not be disposed of in general household waste, but recycled in compliance with local government regulations and environmental requirements.

Please dispose of this equipment via a recycling service or centre, or by returning the unit to the respective Minelab outlet as appropriate for your unit. This will enable the equipment to be disposed of in an environmentally safe manner.

Disposal of unwanted electronic equipment in land filled waste may contribute to adverse long term environmental effect due to the leaching of contaminating and toxic substances contained within some electronic equipment.

THIS DEVICE COMPLIES WITH PART 15 OF THE FCC RULES

Operation is subject to the following two conditions: (1) this device may not cause harmful interference, and (2) this device must accept any interference received, including interference that may cause undesired operation.

Disclaimer:

The Minelab metal detector discussed in this operating manual has been expressly designed and manufactured as a quality hobbyist metal detector and is recommended for use in coin, treasure and general metal detection in non-hazardous environments. This metal detector has not been designed for use as a mine detector or as a live munitions detection tool.

© Minelab Electronics Pty Ltd

This document contains proprietary information which is protected by copyright. Apart from any use as permitted under the Copyright Act 1968, no part may be reproduced by any process without written permission from Minelab Electronics Pty Ltd, 118 Hayward Avenue, Torrensville, SA 5031, Australia.

WARNING: This document contains Minelab Electronics Pty Ltd rights, technical data or restricted rights data, or both. Patents and trademarks apply.

Please note:

Since there may be a variety of options available for this detector, equipment may vary according to the Model or items ordered with your detector. Certain descriptions and illustrations may also differ (in this manual) from the exact Model that you purchased. In addition, Minelab reserves the right to respond to ongoing technical progress by introducing changes in design, equipment and technical features at any time.

Item Number: 4901 - 0063
Revision: 1.1

Congratulations on Purchasing the Minelab GPX-4500

Gold detecting is a fascinating and rewarding activity enjoyed by people all over the world. By getting to know your GPX-4500 you can become one of the many who find gold and valuable treasure.

The GPX-4500 is Minelab's most advanced gold detector. It is a high precision instrument incorporating Multi-Period Sensing (MPS), Dual Voltage Technology (DVT), Smart Electronic Timing Alignment (SETA), and the latest in high-tech analogue components combined with advanced digital processing.

The GPX-4500 will locate gold in all types of ground, especially highly mineralised ground conditions, with greater efficiency than any previous detector.

This manual is designed to help both the beginner and expert prospector get the best performance out of the GPX-4500.

Minelab wishes you every success in your quest for gold and treasure!



Quick Start	Back Cover
Introducing the GPX-4500	4
List of Parts	6
Assembly	8
Adjusting the Detector for Comfortable Detecting	16
Charging the Battery	18
Battery LED Patterns	20
Taking Care of Your Battery	21
Detecting Basics	22
Detector Sounds	23
Front Control Panel	24
Rear Control Panel	25
Turning the Detector On	26
LCD Menu Structure	27
Search Mode	28
Tune / Reducing Electrical Interference	32
Auto Tune	33
Threshold / Adjusting the Background Audio Level	34
Soil/Timings / Optimising for Soil & Target Types	36
Ground Balance / Reducing Ground Noise	38
Ground Balance Procedure for Tracking	40
Ground Balance Procedure for Fixed	42
Coil/Rx / Changing Transmit and Receive (Rx) Fields	44
Resetting Factory Presets	46
Factory Presets	48
Function Select	50
Setting	51
Accessing Functions	52
Accessing Settings	53

LCD Backlight	54
Battery / Viewing the Battery Voltage	55
Volume Limit / Setting the Max Volume of all Sounds	56
Ground Balance Type	58
Ground Balance Procedure for Specific	60
Special / Soil/Timings	61
Manual Tune / Reducing Electrical Interference	63
Changing Search Modes	64
Motion / Adjusting Sweep Speed	66
Rx Gain / Adjusting the Sensitivity of the Detector	67
Audio Type / Changing the Response of Target Signals	68
Audio Tone / Adjusting the Pitch of the Threshold	69
Stabilizer / Controlling the Stability of the Threshold	70
Signal Peak / Adjusting Pitch Variation of Target Signals	72
Target Volume	73
Response / Inverting the Pitch of the Target Signal	74
Tracking Speed / Keeping up with Changing Ground	76
Iron Reject	78
Iron Reject / Rejecting Ferrous Targets	80
Custom Name	82
Pinpointing / Locating the Target	84
Recovering the Target	86
Detecting Tips	88
Commander Coils	90
Choosing the Right Coil for the Job	92
Troubleshooting	94
Glossary of Terms	95
Taking Care of Your Detector	98
Technical Specifications	99
User Preferences	100
User Notes	102
Warranty	103
Service Repair Form	104

4 | Introducing the GPX-4500

5 | Functions Overview

The GPX-4500 utilises Minelab's proven 'Dual Voltage Technology' (DVT). This ensures an accurate Ground Balance to provide maximum sensitivity and depth in all ground types.

The GPX-4500 offers a total of six Timing options, each incorporating the all-new SETA technology. Smart Electronic Timing Alignment (SETA) ensures the detector is precisely aligned for each individual Timing option. This improvement in calibration reduces the susceptibility to certain types of interference, and significantly improves the detector's immunity to highly magnetic rocks and soils.

Through a process of dynamic noise compensation, SETA ensures that the threshold stability is improved and maintained, allowing you to operate the GPX-4500 with maximum efficiency under all conditions.

The GPX-4500 now offers six preprogrammed Search Modes, set up for the most common search techniques.

All modes can be fine tuned by simply scrolling through the various functions of the detector and adjusting the settings.

With improved functionality and new timings the GPX-4500 is capable of finding nuggets in a diverse range of ground conditions with greater ease than previous detectors.

Rx Gain

The Rx Gain function sets the overall sensitivity level of your detector. In areas where soil conditions are mild you can increase the Rx Gain. In areas that are more difficult Rx Gain can be reduced.

Timings

The GPX-4500 features a number of new timings, increasing performance in different conditions.

Ground Balance (GB) Type

Ground Balance Type now has three settings: Normal, Specific, and GB Off. Normal is the preferred setting for most soil types. Specific Ground Balance is designed to be used in very hot ground, and is especially useful with Monoloop coils. GB Off switches the ground balance circuit off for maximum depth in very mild soils, sand etc.

Response

The Response function allows you to invert the target response. Deep targets can now sound like the more familiar 'rising and falling' pitch of a shallow target signal.

Motion

The speed at which you sweep the coil has an effect on target response time and Ground Balance adjustment. Matching your preferred coil sweep speed with the corresponding Motion setting can reduce noise and improve your ability to pick up targets at depth.

Custom Search Mode

With Custom selected, a range of new custom search mode positions become available from the LCD menu. A new mode name picker is also included. Create your own modes for different locations and use them for future visits.

Stabilizer

This is a new feature which allows you to fine tune your audio, to obtain the best compromise between smooth operation and clear target signals.

Target Volume

Used to control the built-in amplifier which affects the volume of target signals. It is active with both headphones and an external speaker. Target Volume can also be used to reduce the severity of ground signals.

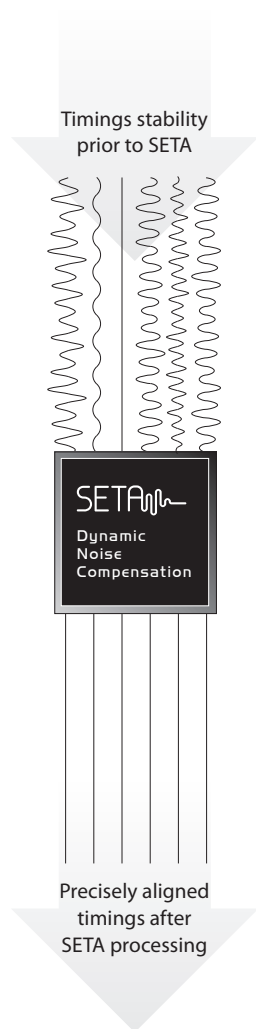

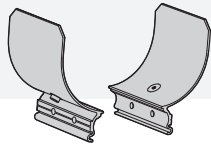

Armrest (2 sections)

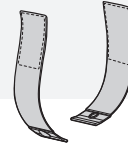

Armrest Straps

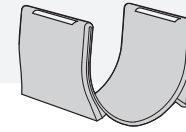

Armrest Cover

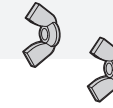

Armrest Wingnuts

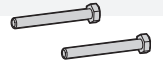

Armrest Bolts

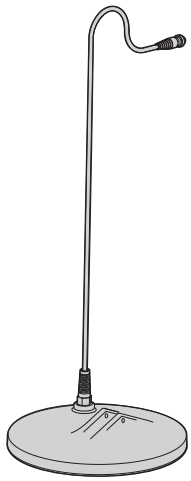

11" DD Coil

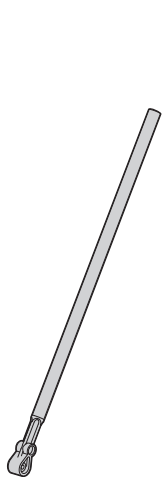

Lower Shaft

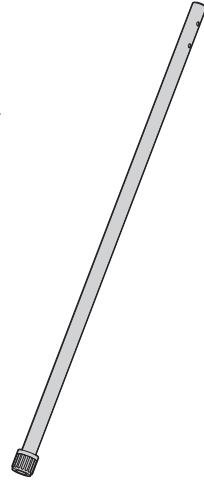

Upper Shaft

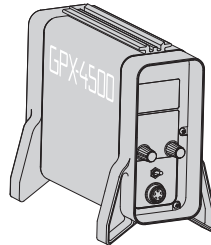

Control Box

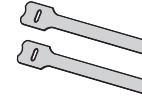

Velcro Tabs

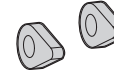

Lower Shaft Washers



Lower Shaft Wingnut



Lower Shaft Bolt

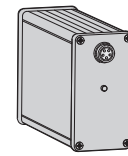

Lithium Ion Battery

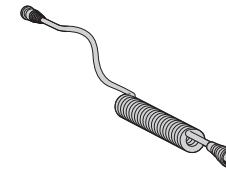

Power Cable

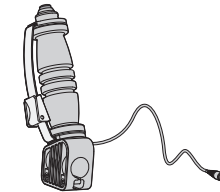

Handle (with Quick-Trak Button)

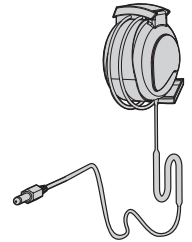

Headphones

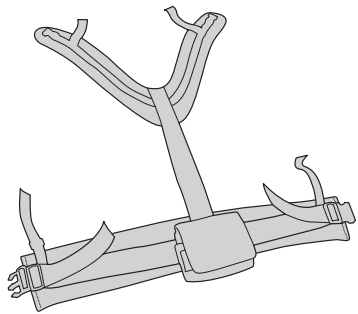

Battery Harness



Bungy Cord Clamp (Bow Knuckle) with Bolt and Wingnut



Bungy Cord

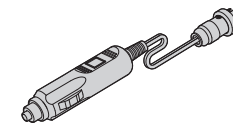

Vehicle Charger Adaptor

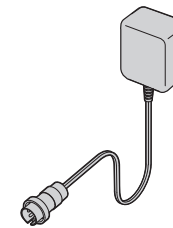

Mains Charger Adaptor

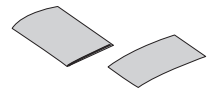

Instruction Manual & Warranty Card

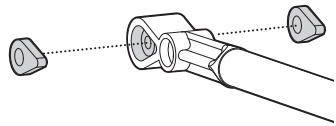

Attaching the Coil to the Lower Shaft:

- 1 Plug the two rubber washers into the holes on either side of the lower shaft.
- 2 Ensure that the spring loaded pin of the lower shaft is pointing downwards. Slide the lower shaft into the bracket on top of the coil.
- 3 Insert the bolt through the lower shaft and the bracket on top of the coil. Fasten with the nut provided; being careful not to damage the thread of the nut by over-tightening. This may need to be loosened to adjust the coil to a comfortable detecting angle.

Note: If the coil becomes loose over time the rubber washers may need replacing.

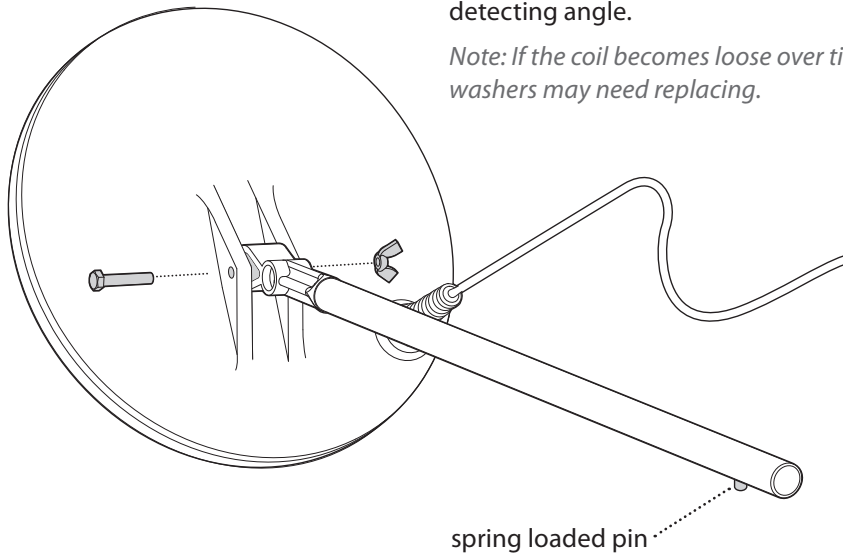

The Coil cable is directly wired into the coil and is not removable. Any attempt to disconnect this cable will void your warranty

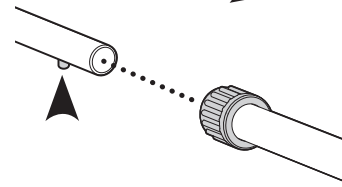
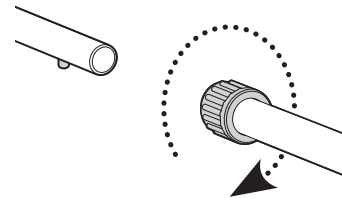
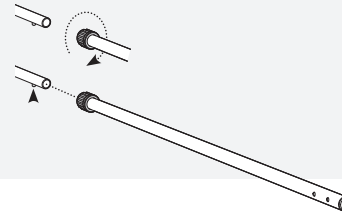

Attaching the Lower Shaft to the Upper Shaft:

- 1 Rotate the twistlock of the upper shaft counter-clockwise to ensure it is loosened.
- 2 Compress the spring loaded pin of the lower shaft. Slide the lower shaft into the upper shaft until the pin reaches an adjustment hole. The pin will spring out and clip into place.
- 3 Rotate the twistlock clockwise to clamp the lower shaft and prevent movement.

Attaching the Handle to the Upper Shaft:

- 1 Slide the bungy cord clamp onto the upper shaft.
- 2 Slide the handle onto the upper shaft so it slopes away from you, as seen below.

Attaching the Armrest to the Upper Shaft:

- 1 Place the two armrest halves on either side of the upper shaft, aligning the armrest and upper shaft holes.
- 2 Insert the bolts through the armrest and upper shaft holes.
- 3 Loosely fasten the wing-nuts onto the bolts (these will be tightened after the control box is attached).

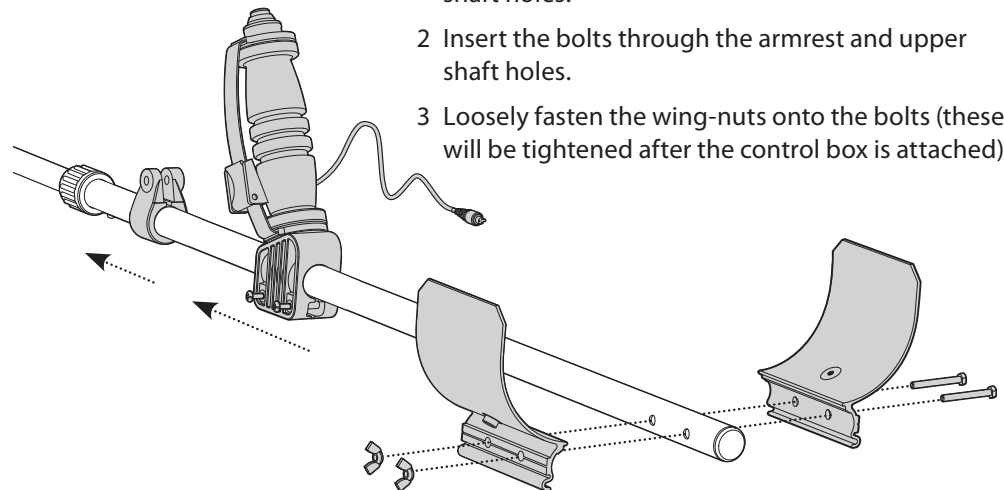

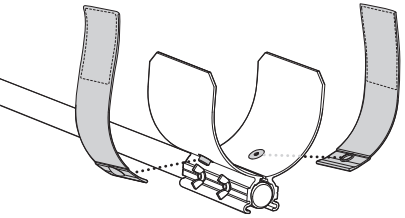

Attaching the Armrest Strap to the Armrest:

- 1 Press both strap studs onto the armrest studs.
- 2 Push the armrest straps through the slots in the armrest cover and then slide the cover over the armrest.

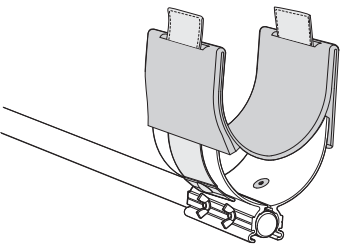

Connecting the Control Box to the Upper Shaft:

- 1 Place the detector on a flat surface, with the handle facing upwards.
- 2 Position the armrest on top of the control box.
- 3 Clip the control box onto the armrest, ensuring the battery plug faces away from the coil.
- 4 Fasten with the wing-nuts.
- 5 Wind the Quick-Trak button cable around the upper shaft and plug it into the Smart Point socket in the control box. Ensure that the cable is wrapped firmly but avoid strain on the connector.

Note: If the Quick-Trak cable becomes loose try securing it onto the shaft with electrical tape.

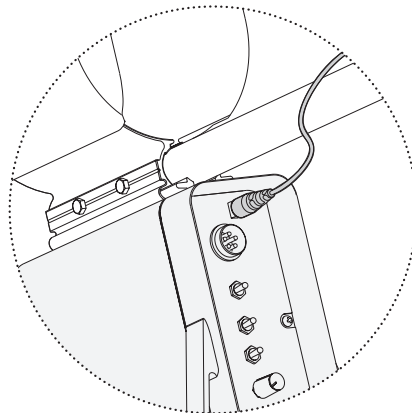
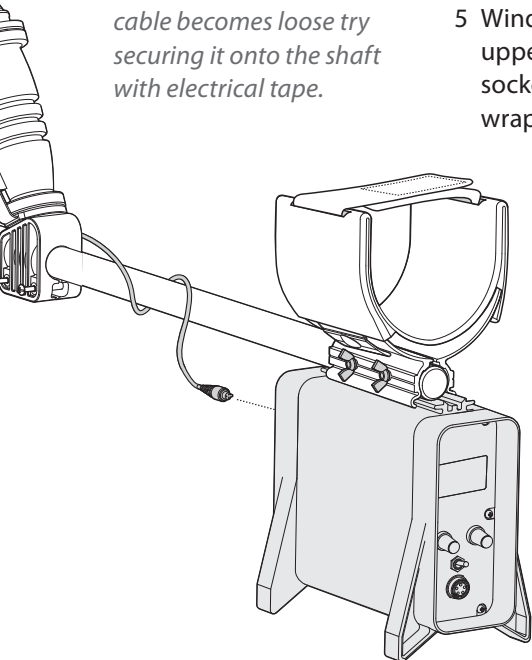

Always ensure that the control box is turned off before connecting or disconnecting the coil to avoid damage to the detector's electronics.

Connecting the Coil Cable:

- 1 Wind the coil cable around the lower and upper shafts enough times to take up the slack. Leave enough slack at the bottom of the cable near the coil to allow the angle of the coil to be adjusted while detecting.
- 2 Use the velcro straps to secure the coil cable to the shaft.
- 3 Plug the coil connector into the coil socket on the control box, firmly tightening the retaining ring to hold it in place.

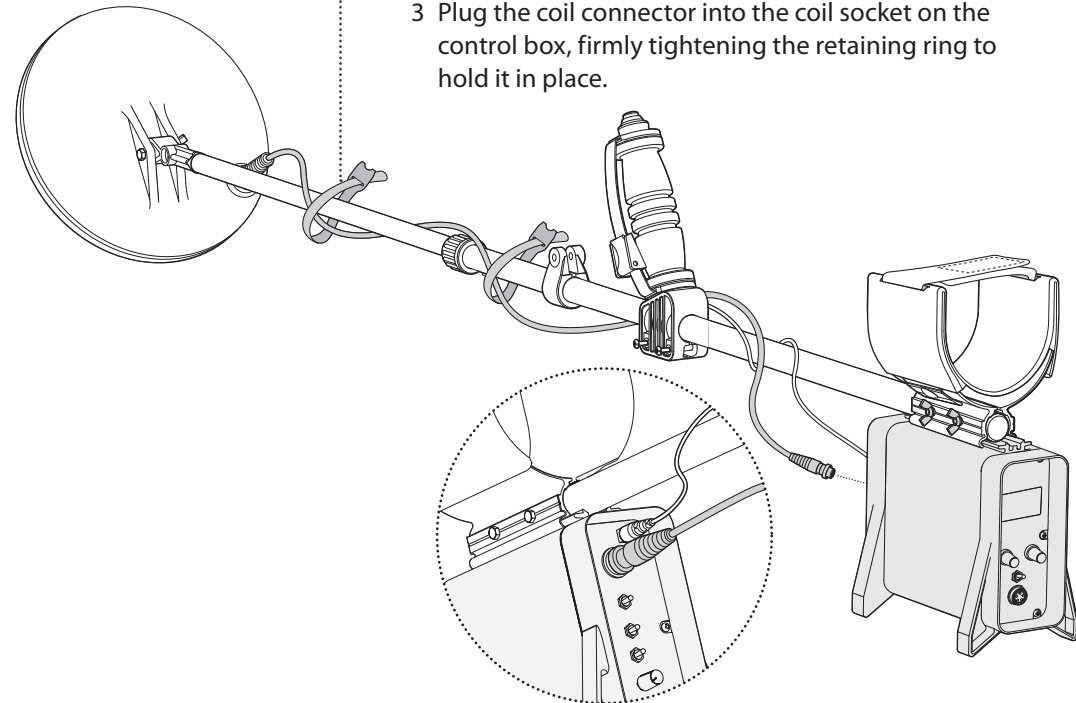

Connecting the Battery Pack:

- 1 Place the battery into the battery harness pouch.
- 2 Connect the headphones and the power cable to the appropriate sockets in the battery.

Note: The illustration shows the battery orientated for a user holding the detector with their left hand.

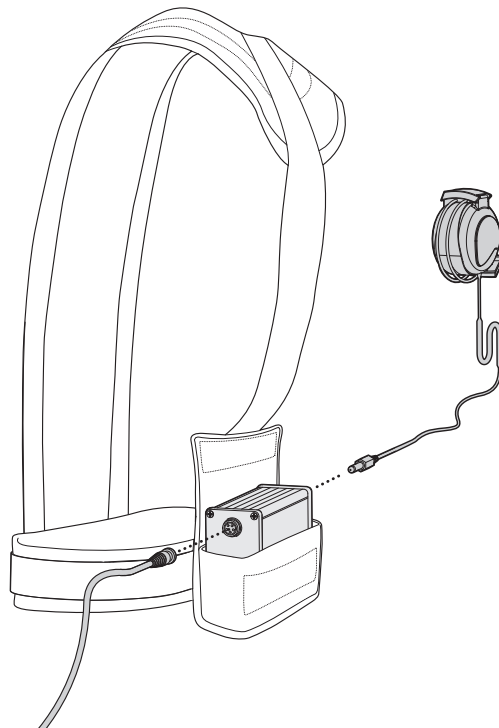

Caution: The battery should initially be charged for 8 hours before use.



Caution: Never re-wire your headphones so that they are similar to the external speaker as the audio level may damage your hearing.

Note: After market accessory boosters may not operate in conjunction with this built in amplifier. However, the detectors 'Target Volume' adjustment allows you to adjust the target signal volume and threshold, so accessory boosters are unlikely to be needed.

Making use of the GPX-4500 Amplifier:

In previous Minelab detectors if a speaker was used, instead of headphones, the audio level would be significantly reduced. Now, the new Minelab Lithium Ion battery contains an additional amplifier which automatically increases the audio level when a correctly wired speaker is used.

The new Minelab Lithium Ion battery will automatically detect if headphones or a speaker is in use and adjust the audio level accordingly.

See wiring diagram below for correct speaker to audio jack wiring.

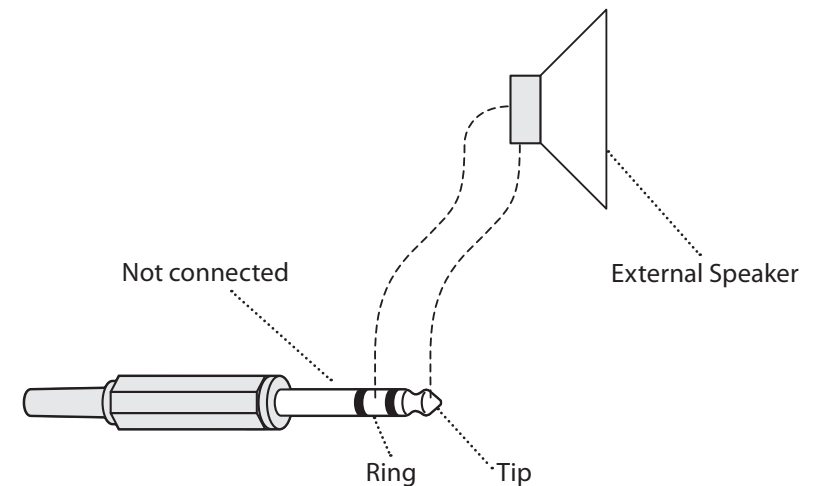

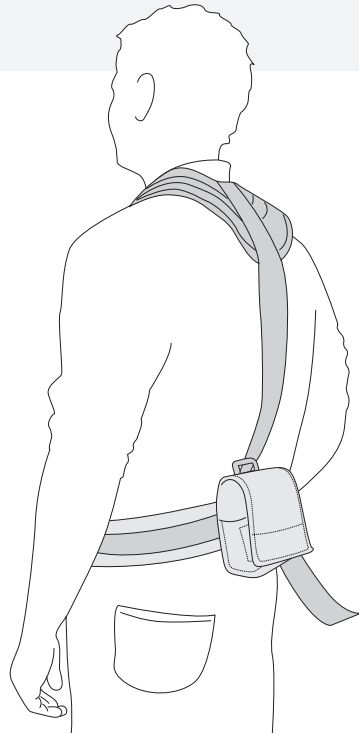
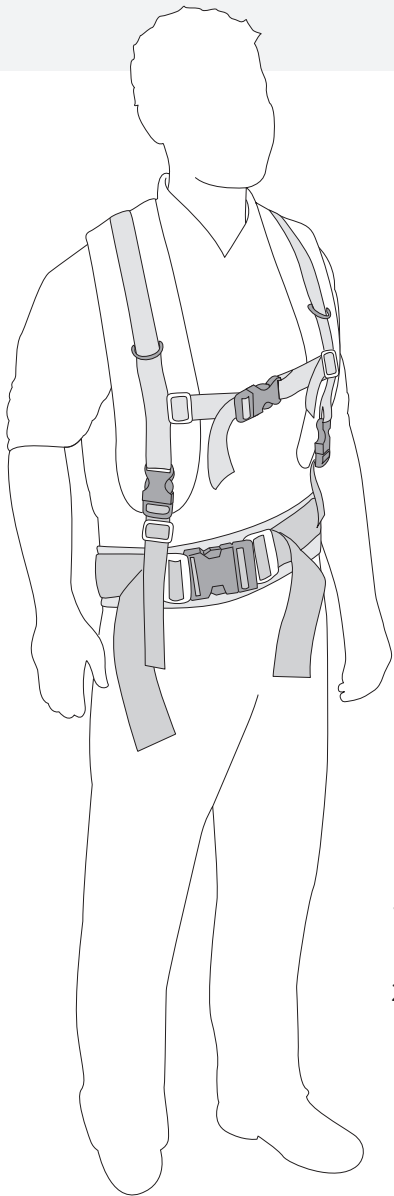

Fitting the Battery Harness:

- 1 Thread your arms through the harness, so the battery pack sits on your back.
- 2 Clip the waist and chest buckles together.

For more detail see *Adjusting the Detector for Comfortable Detecting (pg. 16)*.

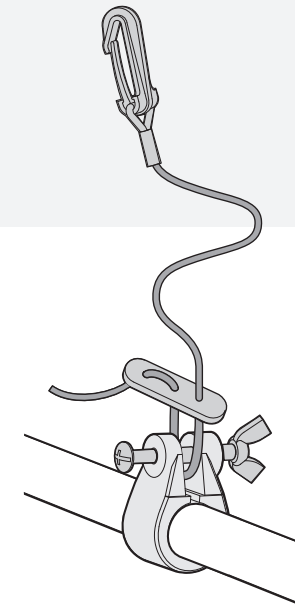
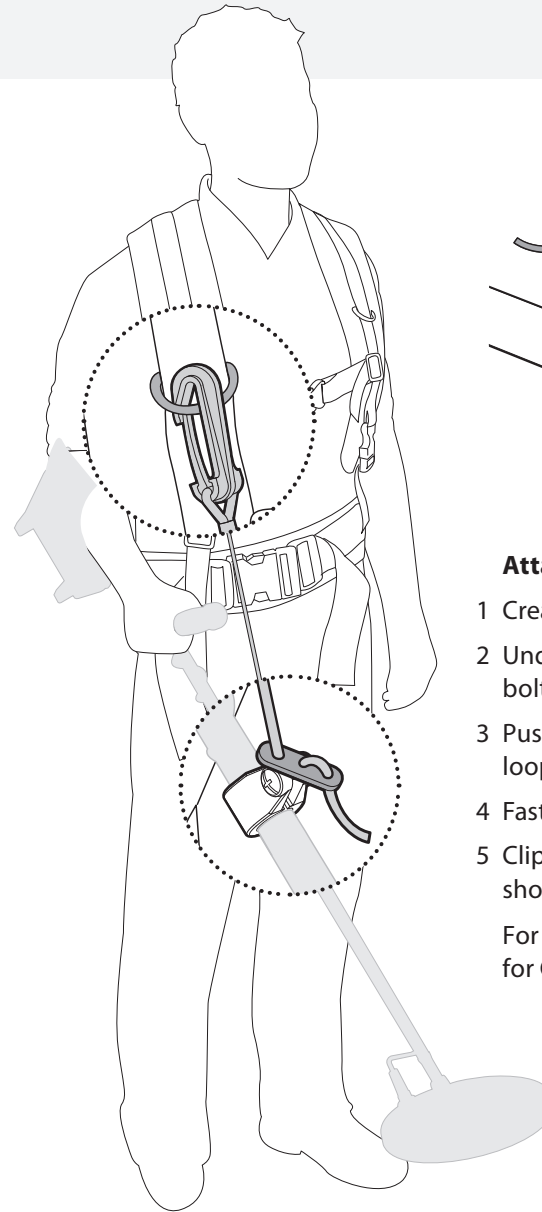

Attaching the Bungee Cord:

- 1 Create a loop in the bungee cord.
- 2 Undo the plastic wingnut and remove the bolt from the clamp.
- 3 Push the bolt back through the clamp and loop to secure the bungee cord to the shaft.
- 4 Fasten the screw with the wingnut.
- 5 Clip the bungee cord onto one of the harness shoulder strap rings.

For more detail see *Adjusting the Detector for Comfortable Detecting (pg. 16)*.

16 Adjusting the Detector for Comfortable Detecting

Note: For comfortable, long term detecting, it is important you take the time to adjust the detector correctly.



Holding the Detector:

Thread your arm through the armrest and strap. Grasp the handle of the detector and rest your forearm in the armrest.

Adjusting the Position of the Handle:

Your elbow should sit just above the back of the armrest allowing you to comfortably grip the handle.

Slide the handle into position. Using a screwdriver, tighten the two screws which hold the handle onto the shaft. Adjust the handle strap to a comfortable position.

Adjusting the Length of the Lower Shaft:

If the coil is too far from your body it will be difficult to balance and manoeuvre while detecting.

If the coil is too close to your body it may detect your pick, the battery, or any other metal which you are carrying; causing confusing sounds.

Rotate the twistlocks of the shafts counter-clockwise to ensure that they are loosened.

Compress the spring pins of the shafts and move them up or down to suit. Once all shafts are clipped into position, rotate twistlocks clockwise onto the shafts until they are firmly clamped.

The correct length of the lower shaft should allow you to swing the coil in front of your body without any uncomfortable stretching or stooping.

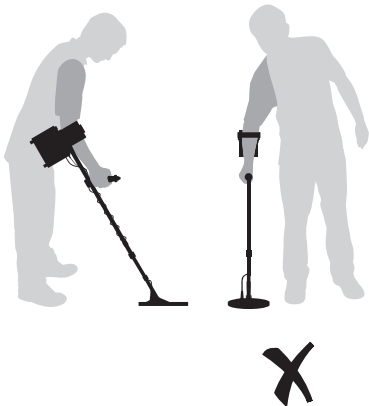

Tip: Some operators may find it more comfortable to fit the battery around the waist. However, make sure the GPX-4500 isn't detecting a signal from the battery. If using a large coil, position the battery as high up on your back as practical (and comfortable) to avoid any unwanted interference.

Adjusting the Battery Harness:

A comfortable fitting battery harness will ensure the longest detecting session possible without fatigue.

Ideally the battery should be placed on your back so that it counter-balances the weight of the detector. You should be able to reach the switches of the detector without putting excess strain on the bungee cord.

Pull the straps outwards and downwards to tighten. Push the straps back through the buckle to loosen.

The harness may also be adjusted around your body by threading the front straps through different loops on the waistbelt.

Adjusting the Bungee Cord Clamp (Bow Knuckle):

The correct position of the bungee cord clamp (bow knuckle) along the shaft can help take the weight of the coil.

Loosen the clamp screw so it can slide along the shaft. Slide it to a position that feels most comfortable for you.

Note: You may need to change the length of the bungee cord, or the position of the bungee cord clamp, when you change coils or detect on sloping ground.

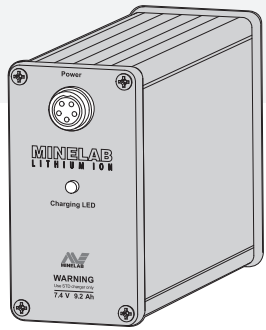

Tip: A spare battery is available as an accessory. If travelling into remote areas a spare battery will ensure you can continue detecting for long periods of time.

The aluminium battery case contains the 7.4V Lithium Ion (Li-Ion) battery pack and an internal charging circuit. Supplied with the GPX-4500 is a mains charger adaptor and a 12V vehicle charger adaptor.

When fully charged, the battery will provide enough power to operate the detector for approximately 12 hours.

The charger will recharge a flat battery in approximately 5 hours, but partially discharged batteries require a shorter recharge time. There is no need to fully discharge the Li-Ion battery before recharging, it can be recharged at any time you are not detecting.

Note: Some after market coils can drain the battery at a higher rate which may reduce your operating time by up to 30%.

Mains Charger Adaptor

The mains charger adaptor will charge the battery from local mains (AC) power outlets.

To Charge with the Mains Charger Adaptor:

- 1 Disconnect the power cable from the battery.
- 2 Connect the mains charger adaptor to the battery power plug and the wall socket.
- 3 Switch the wall socket on.

The colour scheme of the tri-colour LED (pg. 20) will indicate the status of the charging process.

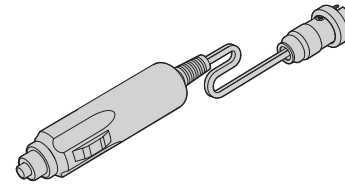

Vehicle Charger Adaptor

The vehicle charger adaptor will charge the battery from the accessories socket (cigarette lighter) of most motor vehicles. The socket must be 12–24VDC.



To prevent damage to the battery, do not start the vehicle's engine while the battery is connected.

Make sure your vehicle's battery is in good condition before using it to charge the GPX-4500 battery.

To Charge with the Vehicle Charger Adaptor:

- 1 Disconnect the power cable from the battery.
- 2 Connect the vehicle charger adaptor to the battery and to the vehicle accessories socket.

The colour scheme of the tri-colour LED (pg. 20) will indicate the status of the charging process.

Note: Don't leave the battery on charge in a closed vehicle on a hot day as it is temperature protected and will stop charging.



Caution: The battery should initially be charged for 8 hours before use.

Routine

Brief cycling red-orange-green:	Occurs when the charger is turned on or when a new battery is connected
Solid orange:	First phase of charge
Orange with green blink:	Last phase of charge
Solid green:	Battery is charged

Exceptions

Slow red blinking:	The battery is too hot. It has reached a temperature over 50°C (122°F) and will not charge. Disconnect the battery and wait for it to cool below 40°C (104°F) in a cool place before reconnecting.
Continuous orange blinking:	The first phase of charging has timed out. If this continues to occur each time the battery is charged the battery is no longer functioning correctly. Contact your dealer.
Solid red:	There is a fault with the battery. Disconnect and reconnect the battery. If the LED is still red contact your dealer.

The Lithium Ion battery is specifically designed for the GPX-4500.



The Lithium Ion battery is not compatible with non GPX detectors. The GPX-4500 is supplied with a power lead which has been specifically designed to fit GPX detectors only. Attempting to use the Lithium Ion battery pack with other detectors may damage the detector or the battery pack. Do not try to adapt this battery to other models as it will very likely cause damage.

- Do not charge the battery at temperatures above 45°C (113°F).
- Do not charge the battery at temperatures below 0°C (32°F).
- Do not leave the battery in hot conditions (e.g. on the dashboard of your car or rear parcel shelf).
- Do not immerse the battery in any liquid or allow water ingress.
- Do not throw the battery or impact it in any way.
- Do not short-circuit the battery.
- Do not use the battery if it is damaged or deformed.
- Do not disassemble or reconstruct the battery.
- Do not incinerate the battery.

In the event of a fault, you should return the battery to a Minelab authorised service centre for repair.

The use of non-approved components will **VOID YOUR WARRANTY**.

There are no user serviceable parts within this battery pack.

Note: The GPX-4500 is a 'motion' detector. This means it must be moving over a target to detect it.

The GPX-4500 will perform at its best when the coil is kept close and parallel to the ground at all times. This will increase the detection depth and target response to small objects.

A variation in coil height at the end of each swing may cause confusing sounds and reduce detection depth; an even flat sweep is desirable.

Practise sweeping the coil over the ground in a side-to-side motion, while walking forward slowly at the end of each sweep. Slightly overlap the previous sweep to ensure full ground coverage. An average sweep speed is four seconds from left to right to left.

Tip: When using a Monoloop coil more overlap is required to ensure that targets at maximum depth are not overlooked (see pg. 90 for a diagram showing coil search patterns).

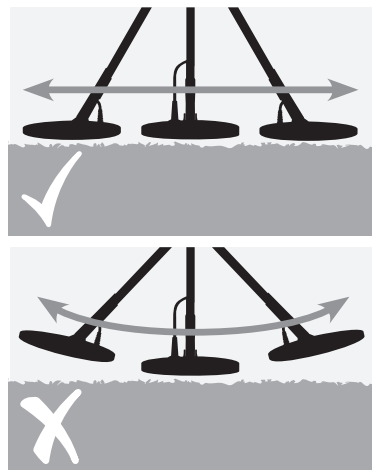
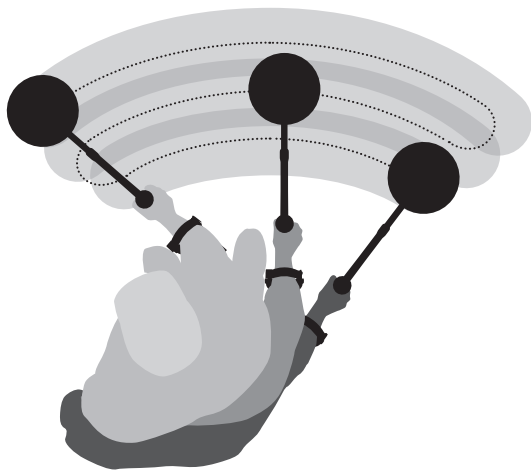

Target Response (Metal Object Response)

This is a change in the tone (pitch) and volume of the Threshold when a target is detected and not discriminated (rejected).

Threshold (Background sound)

This is the background sound produced by the detector. When a target is detected, the Threshold (*pg. 34*) changes in volume and pitch. Listen to the Threshold carefully. Concentration is an important part of detecting. A very deep or small target may only cause a very small change to the Threshold.

Electrical Interference

The detector may produce random sounds when the coil is motionless. These will not be target signals, but signals caused from the surrounding environment. The GPX-4500 has a Tune (*pg. 32*) function to overcome electrical interference.

Ground Noise

Certain minerals may cause the detector to produce various sounds; often referred to as false signals. The GPX-4500 has an automatic Ground Balance function (*pg. 38*) to overcome ground noise.

Blanking

When the detector is in Iron Reject mode and sweeping over a ferrous target the Threshold 'blanks' (becomes silent), indicating that a target is located underneath the coil but has been rejected. Blanking (*pg. 79*) is a useful way of distinguishing between desired and undesired targets.

Low Battery

When the battery voltage (*pg. 55*) is low, a series of alarm signal pulses are given at one minute intervals.

Threshold (pg. 34) is the background sound produced by the detector. This control increases / decreases the level of the Threshold.

Auto Tune (pg. 33) automatically scans a range of frequency channels to help reduce electrical interference.

Coil Connector
Connects the coil to the control box.

Smart Point is a connection point for the Quick-Trak button located on the handle.

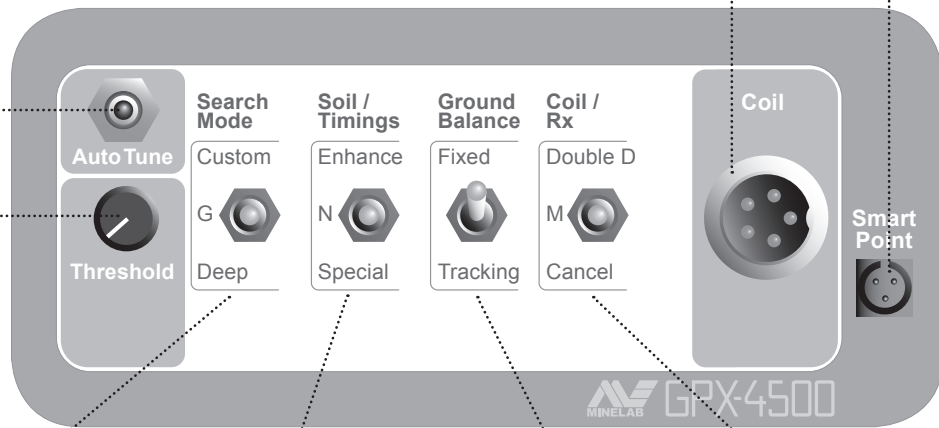

Search Mode (pg. 28) Each Mode has factory preset settings to suit that style of searching. Search Modes can also be customised to suit different detecting conditions.

Soil/Timings (pg. 36) allows you to change the electronic pulses/timings of the detector to optimise performance for different soils and target types.

Ground Balance (pg. 38) reduces the ground noise caused by mineralisation.

Coil/Rx (pg. 44) allows you to change the transmit and receive (Rx) fields of the coil.

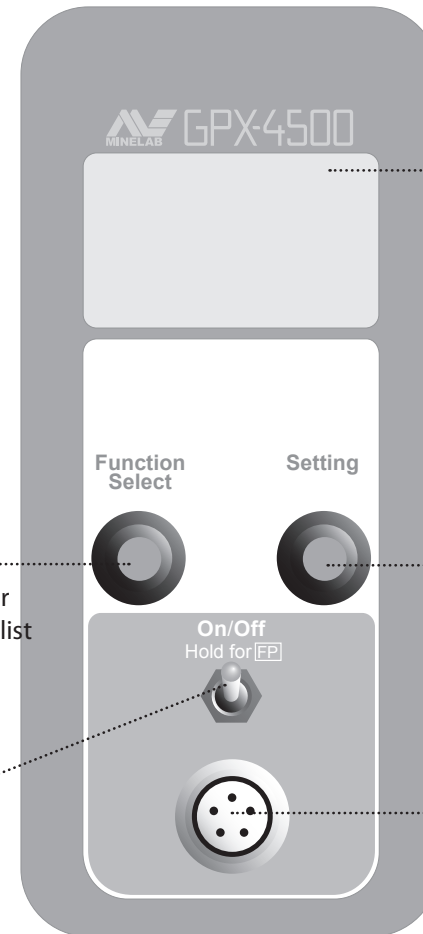

LCD (Liquid Crystal Display) Displays all the menu functions and settings. Now with backlight (pg. 54).

Function Select (pg. 50) scrolls up or down through the list of functions.

Setting (pg. 51) Once a function has been selected, Setting allows you to adjust its value.

On / Off (pg. 26) turns the detector on and allows you to restore Factory Presets.

Battery Connector connects the control box to the battery and headphones.



The On / Off switch is located on the rear control panel.

To turn the detector on or off:

Press and release the On / Off toggle switch.



It is best to only turn the detector on when outdoors and away from sources of electromagnetic disturbance such as power lines, transmitters, electric fences and phone towers. These sources may cause the detector to perform erratically, giving numerous false signals.

Note: If the detector emits an overload sound move the coil away from any large metal objects. Overloading is not harmful to the electronics of the detector.

Many of the GPX-4500 functions are accessed through the LCD Menu. These are explained in further detail throughout the rest of this manual.

Until you become more familiar with the GPX-4500, the detector can simply be operated with the Factory Presets (pg. 48) and the front panel controls.

Functions

MAIN MENU		▼
BACKLIGHT		2
BATTERY TEST		
VOL LIMIT		12
GB TYPE		GEN
SPECIAL		EXTRA
MAN TUNE		128
GENERAL		◆
MOTION		SLOW
RX GAIN		8
AUDIO		NRM
AUDIO TONE		50
STABILIZER		10
SIGNAL		15
TARGET VOL		8
RESPONSE		NRM
TRACKING		MED
IRON REJECT		OFF

Settings

BACKLIGHT	2
BATTERY VOLTS	7.4v
VOLUME LIMIT	12
GB TYPE	GENERAL
SPECIAL	SENS EXTRA
MANUAL TUNE	128
MOTION	SLOW
RX GAIN	8
AUDIO TYPE	NORMAL
AUDIO TONE	50
STABILIZER	10
SIGNAL PEAK	15
TARGET VOLUME	8
RESPONSE	NORMAL
TRACK SPEED	MEDIUM
IRON REJECT	OFF



Avoid turning the detector on and off repeatedly. If this happens the Coil Overcurrent screen will appear. Turn the detector off and wait for a short time before turning the detector on again.

Search Mode

Custom



Deep



Deep

The GPX-4500 has three Search Mode switch positions: General, Deep and Custom.

Each Search Mode switch position has a series of Factory Preset settings saved so that you can start detecting right away. After you are familiar with the GPX-4500 these can be customised with personal preferences to suit different detecting conditions.

The General and Deep modes have their own switch position. Custom Mode position is for one of the four additional search modes (pg. 64), which you can select through the LCD menu.

General (G)

The General Mode will provide the best compromise of sensitivity, stability, depth and signal response under a variety of conditions. For this reason it is likely that General will be your primary search mode, reserving the others for a specific task or scenario.

Deep

The Deep Mode should be used when you are detecting a small area very slowly and carefully; such as when chaining or cross-gridding a run of nuggets on a slope. Deep Mode is optimised for a very slow sweep to provide maximum depth, on large targets.

Custom



Custom

The Custom Search Mode provides a choice of four additional search modes (pg. 64) which can be selected from the LCD menu.

- These are: – Patch (Factory Preset Selection)
 – Hi-Mineral
 – Hi-Trash
 – Test A

This allows a total of six separate search modes which can be set up for different circumstances.

The Main Menu MAIN MENU
 functions are the same for each Search Mode.

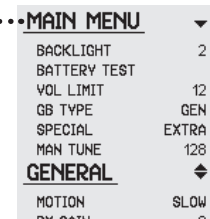

The functions for each of the six Search Modes GENERAL
 can be saved with different settings.

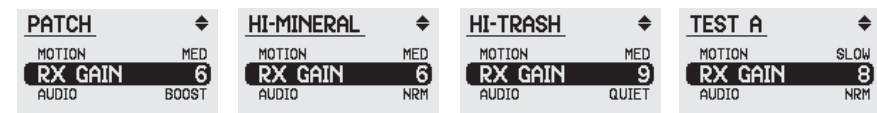

Search Mode

(Continued)

Selecting Custom Mode

When the Search Mode switch is in the Custom position each of the four Custom Search Modes (pg. 64) are available, and can be selected from the LCD menu.

The four Custom Search Modes are:

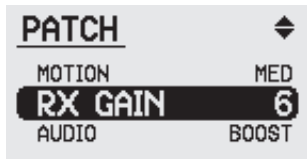

Custom Search Mode - Patch

The Patch mode is set up for prospecting unknown ground when you are likely to be walking and detecting faster, seeking a first nugget that may indicate a new area worthy of further investigation.



Custom Search Mode - Hi Mineral

This mode will help to stabilise the detector in highly mineralised soils, yet still remain sensitive to small and deep targets. You may need to adjust the Rx Gain setting to suit your particular location.



Custom Search Mode - Hi Trash

This mode has factory presets specifically selected for detecting in an area containing a lot of rubbish. The Iron Reject (pg. 78-81) setting has been factory set quite high so you may want to reduce this if you want to be more cautious.



Custom Search Mode - Test A

This is a default mode initially set with the same settings as General, which you can use to experiment with and compare with other modes.

All four of these Custom Search Modes can be renamed (pg. 82).

Reducing Electrical Interference



Tip: If you would like to know what channel has been chosen after an automatic Tune, access the Manual Tune screen and check the number displayed.

The detector may be affected by electrical interference from powerlines, radio transmitters electrical equipment or other detectors operating close by. This interference causes the Threshold to become erratic.

So that the detector experiences the least interference for the current environment the search channel can be changed automatically by the Auto Tune button on the control panel, or manually in the Manual Tune (pg. 63) setting via the LCD menu.

Auto Tune instructs the detector to automatically listen to every channel and select the quietest position. Automatic tuning may take up to 60 seconds.

The Manual Tune setting, via the LCD menu, allows you to manually select and listen to every channel for the least interference.

The best channel to select will be the one where the audio response to electromagnetic disturbances (e.g. powerlines) is the lowest.

It is best to tune with the coil away from the ground and as stationary as possible. This gives the detector the best chance of sensing all surrounding interference (not associated with the ground or targets) too select the quietest channel.

Note: Interference in some locations can change during the course of the day so you may need to re-tune from time to time to maintain a stable Threshold as you move around the area.

There is only one Tune setting. Any changes made manually will override the Auto selection.

Note: Tuning should be done initially with the Coil switch in Double-D or in Monoloop (M). If the interference is still severe after completing the tuning operation change the Coil switch to Cancel and then re-tune the detector if necessary.

To Perform an Automatic Tune:

- 1 Hold the detector at waist height, with the coil vertical, and slowly rotate through a half-circle. Make sure there are no large targets or obvious electrical interference sources close by.
- 2 Face the direction of the most interference and hold the coil steady.

If you have difficulty holding the detector very still for 60 seconds, you can place the detector on the ground with the coil vertical.

- 3 Press the Auto Tune button. Keep the detector completely still during the automatic channel scanning process.

A single beep indicates the beginning of the Auto Tune. The detector will begin to scan each channel for the least interference. This may take up to 60 seconds.

The detector will select the quietest operating channel identified. The end of the Tuning process will be indicated by three sharp 'beeps'.

When tuning the detector in close proximity to other detectors, each operator needs to take turns tuning. Do not try to tune two detectors at the same time.

Any interference is made more obvious with a faster Motion setting (pg. 66). Therefore, you can assist the Auto Tune function in selecting the quietest frequency band by selecting Fast Motion before performing the Auto Tune process. When the process is complete simply return the Motion speed to its original setting.

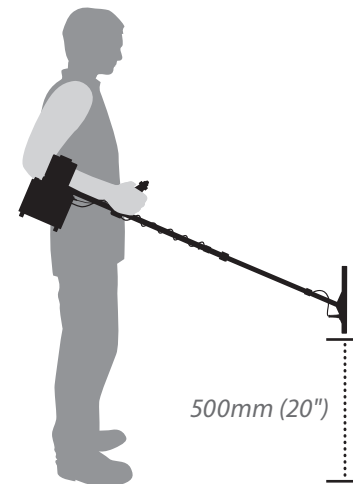

Adjusting the Background Audio Level



Threshold is the constant audible background tone or 'hum' produced by the detector. The Threshold is your reference point and lets you know what the coil is picking up, whether it may be a target, ground noise, or electrical interference, so it is important to set the threshold so it can be heard.

The level of the Threshold should be set low, but still audible and stable. Ideally it should be a smooth, gentle hum. If you set it so that it can't be heard you may set other detector settings incorrectly.

Small targets or large deep targets may not produce a distinct target signal, but may cause only a small variation in the Threshold. If the Threshold level is set too high or too low these very small variations may be missed.

Listening for a target signal with a high Threshold would be like trying to hear a whisper within a crowded noisy room. A high Threshold may also be uncomfortable to your hearing.

If the Threshold is set too low the target signal needs to be loud enough to become audible. Therefore, very soft target signals, from small or very deep targets, may not be heard.

It is important to reset the Threshold level as conditions change. For example, your ears may adjust to the low levels of audio after an hour or so, or the conditions may have become windy.

When the Threshold is too high a faint signal is masked and only the peak of the loud signal is audible above the Threshold.

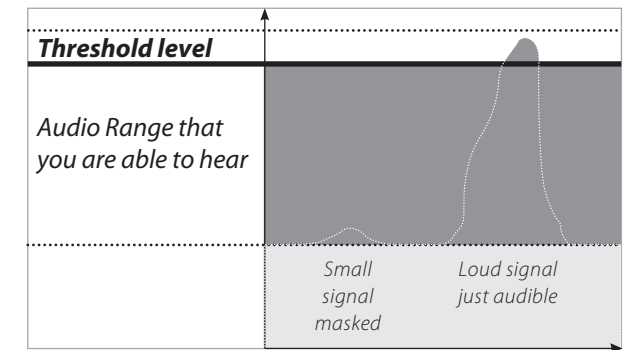

With the Threshold set correctly both target signals are easily heard.

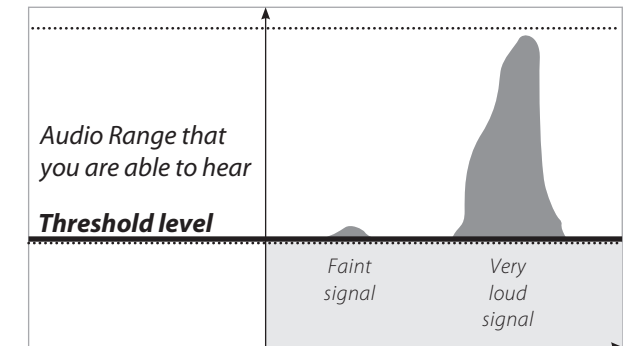

A Threshold level that is too low does not allow faint target signals to be heard.

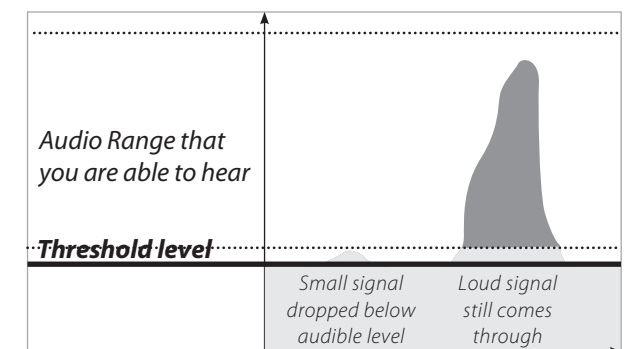

Optimising the Detector for Different Soil and Target Types

Soil / Timings

Enhance



Special

The GPX-4500 Timings define the characteristics of the Transmitter (Tx) and Receiver (Rx). The Soil/Timings switch allows you to choose from a range of different Timings. This optimises the detector for different soil conditions, the type of coil being used and desired target sizes. Soil/Timings can make a big improvement to your finds.

Certain Timings have a particular affinity to certain soil conditions (magnetic, alkaline, neutral, etc.) and on different target sizes and conductivities. By using the Soil/Timings switch, changes to the timings can be made to improve the performance in different conditions.

Note: When switching between Soil/Timings, there is a one second pause (i.e. one second of muted Threshold) before detection continues.

Enhance



Enhance

The Enhance timing is very effective at cancelling most ground noise signals, and significantly reduces the response on hotrocks. It works very well with monoloop coils in all but the most extreme soil conditions. It is very sensitive to a range of target sizes.



Normal (N)

Normal gives you the best performance on a wide range of soil conditions, and it will provide the best depth on a wide variety of target sizes. It works particularly well with the supplied 11" DD search coil for general detecting. You should always use Normal in new areas where you are unsure of the soil mineralisation and the depth of targets.



Special

Special (*pg. 61*) provides a range of specialist timings available from the LCD menu. You can choose between Sensitive Extra; Sensitive Smooth; Salt-Coarse; and Sharp.

Special



Always remember to re-Ground Balance the detector after making any changes to the Soil/Timings switch.

Ground Balance

Fixed



Tracking



Tracking

The ground contains not only sand but also many different chemicals, minerals and salts. These extra materials are referred to as ground mineralisation. This ground mineralisation may often produce erratic sounds known as 'ground noise'.

The Ground Balance (GB) function minimises ground noise ensuring signals from targets, such as gold nuggets, are not confused with false ground signals.

The GPX-4500 has the ability to cancel out the effects of ground mineralisation automatically, and the Tracking function will maintain a perfect Ground Balance while you search.

Tracking

Tracking instructs the detector to cancel the effects of ground mineralisation, and will automatically adjust the Ground Balance setting when ground conditions change during detecting.

Tracking is preferred in heavily mineralised ground, especially where the mineralisation is changeable, or when you want to cover a large area quickly and efficiently.

Fixed



Fixed

Fixed holds the last Ground Balance setting. In ground where conditions allow Fixed will provide greater depth, sensitivity and sharper target signals, provided a perfect Ground Balance is maintained.

Fixed will give slightly improved performance but will require re-balancing (*pg. 42*) when necessary. Using the Quick-Trak button is an easy way to do this.

Note: Where possible, always search in Fixed GB to maximise depth and sensitivity, and only use Tracking in areas with excessive ground noise and/or rapidly changing mineralisation, often referred to as variable ground.

Quick-Trak Button

The Quick-Trak button found on the handle assembly allows you to temporarily switch between Fixed and Tracking or vice versa.

The Quick-Trak button only changes the Ground Balance position (Fixed or Tracking) while the button is pressed. Once the button is released the Ground Balance setting returns to the switch position selected on the front control panel.

The Quick-Trak button will most commonly be used to Ground Balance the detector, and also to fix or hold the Ground Balance setting while pinpointing.

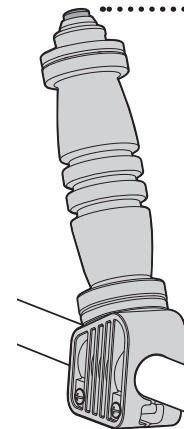

40 Ground Balance Procedure for Tracking

(For Ground Balance Type – General)

- 1 Find a clear area of ground without any targets.
- 2 Change the Ground Balance switch to Fixed.
- 3 Whilst keeping the coil parallel to the ground, lower and raise the coil between 25mm and 100mm (1" and 4") over the ground. Try to lower the coil as close to the ground as possible without touching it.
- 4 While moving the coil change the Ground Balance switch to Tracking and continue moving the coil up and down until the audio has stabilised and any ground noise has stopped.



Note: A persistent signal may indicate a target in the ground. If this occurs, move the coil to a new location and repeat the procedure.

- 5 When there is no longer a change in the Threshold, the detector is 'Ground Balanced', and you can commence detecting.

Note: When changing the Ground Balance switch from Fixed to Tracking a very fast auto-Ground Balance is initiated prior to returning to a normal Tracking speed. This fast Ground Balance only lasts a short time, so it is important to be moving the coil before changing the switch.



Ground Balance reset in Tracking

Whilst sweeping the coil you should periodically test that you are still in harmony with the ground by stopping, then raising and lowering the coil. If the Threshold remains stable then you are still Ground Balanced. If there is a change in the Threshold then you need to reset the Ground Balance setting.

While raising and lowering the coil press and release the Quick-Trak button. A short 'beep' will be heard which lets you know that a three second, fast auto-Ground Balance is initiated prior to returning to Tracking. Once the audio has stabilized you can continue searching.

If you find that the Ground Balance needs to be reset quite regularly, you can select a Faster Tracking speed. Three Tracking speed options (pg. 76) are available from the LCD menu.

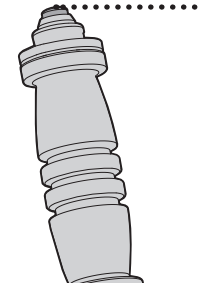

Note: In highly variable ground the Tracking may not instantly update the GB setting when you detect over a large mineralisation change; so there may be a period of time where you will experience some ground signals. To avoid missing any faint target signals you may have to reset the ground balance



As Tracking continually updates the Ground Balance setting, repeated passes over a target may result in the detector balancing to the target instead of the ground; diminishing the target signal and increasing ground noise.

Therefore, it is important to use Fixed when pinpointing or when investigating a potential faint signal with repeated sweeps.

42 Ground Balance Procedure for Fixed

(For Ground Balance Type – General)

Fixed



- 1 Find a clear area of ground without any targets.
- 2 Change the Ground Balance switch to Fixed.
- 3 Whilst keeping the coil parallel to the ground, lower and raise the coil between 25mm and 100mm (1" and 4") over the ground. Try to lower the coil as close to the ground as possible without touching it.
- 4 While moving the coil press and hold the Quick-Trak button. The Tracking program initiates a very fast Ground Balance for a short time.

Note: This is the same effect as changing the Ground Balance switch to Tracking on the front panel.

- 5 Continue moving the coil up and down until the ground noise has stopped. When there is no longer a change in the Threshold the detector is 'Ground Balanced'.

Note: A persistent signal may indicate a target in the ground. If this occurs, then move the coil to a new location and repeat the procedure.

- 6 Release the Quick-Trak button to return to the Fixed position and commence detecting.

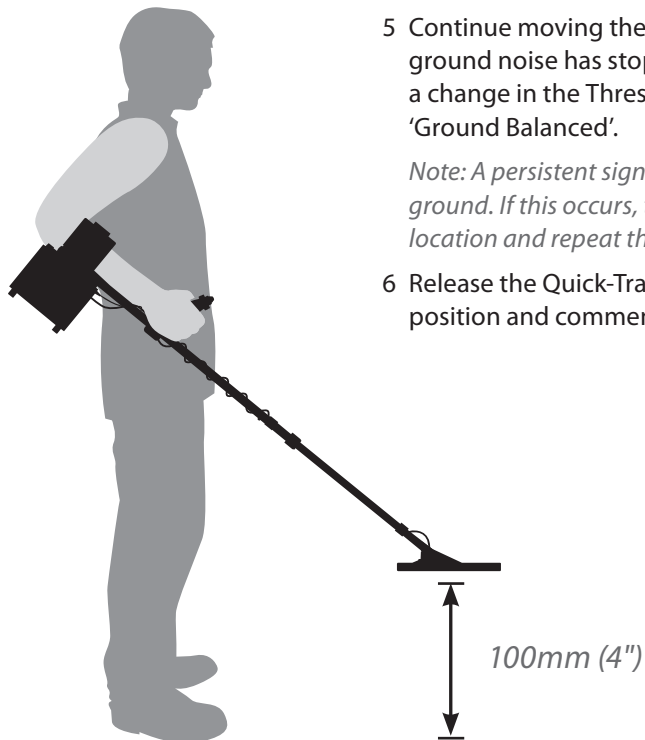

Note: When searching in Fixed it is very important to regularly check the Ground Balance and reset when required. Testing, by raising and lowering the coil, is quick and simple and should become a regular part of your detecting technique.

Ground Balance reset in Fixed

Whilst sweeping the coil to test if you are still in harmony with the ground stop, then raise and lower the coil. If the Threshold remains stable then you are still ground balanced. If there is a change in the Threshold you will need to reset the Ground Balance setting.

This is achieved by simply repeating steps 3–6 of the Ground Balance procedure for Fixed.

Ground Balancing Tips

When going over old patches (i.e. small concentrated areas known to have produced gold nuggets) run in Fixed Ground Balance and periodically re-Ground Balance with the Quick-Trak button every few metres.

When Ground Balancing in very rocky terrain lower the coil to the height above the ground you will actually be swinging at.

In highly magnetic soils you may have trouble ground balancing the coil all the way to the ground (most common with larger Monoloop coils). If you experience this you can change the Ground Balance Type to Specific; which requires a different ground balance procedure (pg. 60).

Changing the Transmit and Receive (Rx) Fields of the Coil

Coil / Rx

Double D



Cancel

The Coil/Rx control changes the sensitivity and search pattern of the coil. This improves the versatility and characteristics of the GP series and Commander range Double-D coils. This is achieved by altering the pattern of transmit (Tx) and receive (Rx) fields of the coil, and how the control box interprets the response. Each switch position changes the electromagnetic field of the coil, thus giving better performance in certain situations.

Coils not specifically designed by Minelab may behave erratically, or be ineffective, in either the Monoloop (M) or Cancel position.



It is very important that you always switch off the detector before changing coils.

Note: You will need to re-Ground Balance every time you select a new position for the 'Coil' switch.

Double-D (DD)

This is the best option for areas of medium to very high mineralisation. It is also excellent for pinpointing, as the target response is strongest from the centre of the coil.

The search pattern in Double D is the conventional blade or wedge shaped signal through the centre of the coil.

Monoloop (M)

This setting may be used in most locations of low to medium mineralisation. Monoloop is also suitable for locating small nuggets with Soil/Timings set to Sensitive Extra in the LCD menu.

Double D

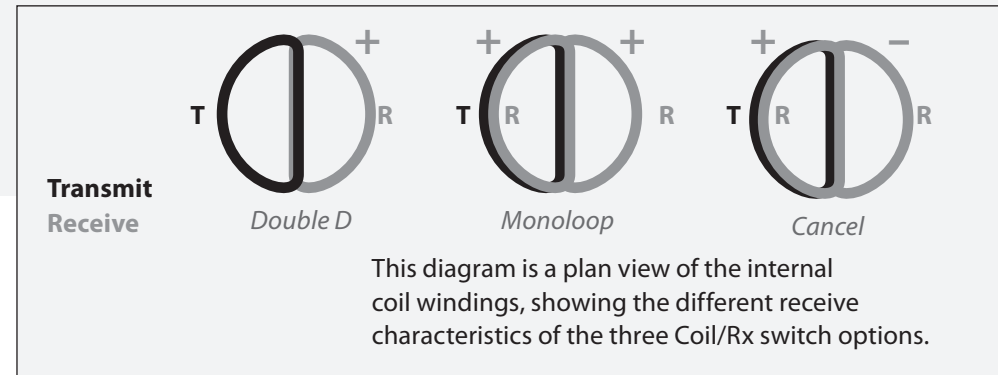

Tip: Minelab Monoloop coils can be used on the GPX-4500 with excellent results. For maximum stability we recommend their use in conjunction with the Coil/Rx switch in Monoloop (M).

Using a DD coil, running in Monoloop will often increase the sensitivity of the detector but may also be a little more unstable in heavily mineralised ground. Pinpointing (pg. 84) is not centred in the middle of the coil, but to the left side, and may give a complex signal when the target is very close to the coil. It is recommended you use the left edge of the coil to pinpoint shallow targets.

Cancel

This setting provides a receive field that is particularly stable in areas of electrical interference. This position is ideal for detecting close to suburbia or where the Tune function has difficulty selecting a quiet operational channel (e.g. near power lines, phone towers or under poor atmospheric conditions).

Pinpointing in Cancel will be to the left side of the coil and signals may be complex if the target is close to the coil. In Cancel, sensitivity and depth are slightly reduced.

You may be able to increase Rx Gain (pg. 67) if using Cancel.



Cancel

Salty Environments: In highly saturated salt conditions, such as ocean beaches or large inland salt lakes, the use of Cancel may give better performance than Salt-Coarse. As a general performance comparison Cancel will be more sensitive, but Salt-Coarse has a greater depth potential on larger targets.



The detector will not detect targets if Cancel is used with a Monoloop coil.

The GPX-4500 is provided with a Factory Preset **[FP]** selection of menu settings, suitable for first-time users.

Until you become more familiar with the GPX-4500 the detector can simply be operated with the Factory Presets and the front panel controls.

To restore all Factory Preset settings:

- 1 Turn the detector off.
- 2 Press and hold the On/ Off switch until the Reset Defaults menu appears (approx. 5–6 seconds).
- 3 Turn Function Select to the right to select All Settings (as shown on the diagram).
- 4 Turn Setting left or right to restore all Factory Presets.

Note: When performing an All Settings reset, the settings for the four Custom Search Modes are preserved. This is to prevent your own favourite mode settings from accidentally being erased whilst allowing the LCD menu, Deep Mode and General Mode settings to be quickly restored to factory settings.

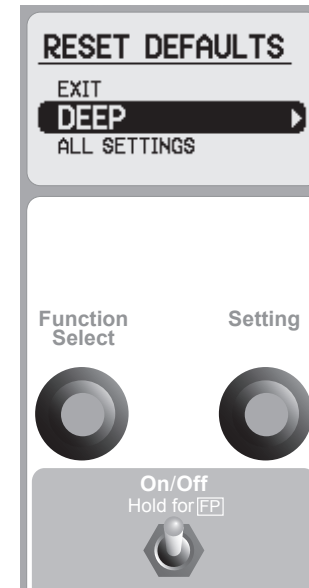
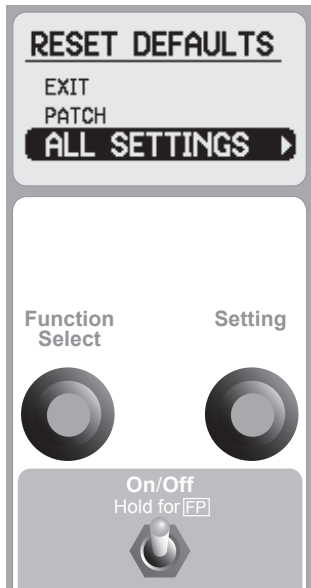

To restore Factory Preset settings for the current search mode:

Note: If you wish to reset a Custom Search Mode ensure it is selected in the menu before shutting down the detector.

- 1 Turn the detector off.
- 2 Press and hold the On/ Off switch until the Reset Defaults menu appears (approx. 5–6 seconds).
- 3 Turn Function Select to the right to select the current mode.

Note: If the displayed Search Mode is not the one you wish to restore you must change the Search Mode on the front panel switch or select the correct Custom Search Mode from the LCD menu.

- 4 Turn Setting left or right to restore Factory Preset settings for that mode.

Main Menu:	Range:	Universal Functions	
		Factory Preset:	
Backlight	Off, 1–8	2	
Battery Test	0–8.0V +8.0V	–	
Volume Limit	1–20	12	
GB Type	General Specific GB Off	General	

Main Menu:	Range:	Universal Functions	
		Factory Preset:	
Special	Salt-Coarse Sens Extra Sharp Sens Smooth	Sens Extra	
Manual Tune	0–255	128	

Search Mode:	Range:	Search Mode Specific Functions	
		General:	Deep:
Motion	Very Slow Slow Medium Fast	Slow	Very Slow
Rx Gain	1–15	8	9
Audio Type	Quiet Normal Deep Boost	Normal	Deep
Audio Tone	1–100	50	38
Stabilizer	1–20	10	10
Signal	1–20	16	17
Target Volume	1–20	8	8
Response	Normal Inverted	Normal	Inverted
Tracking	Slow Medium Fast	Medium	Slow
Iron Reject	Off (All Metal) 1–10	Off (All Metal)	Off (All Metal)

Custom Search Mode Specific Functions			
Patch:	Hi-Mineral:	Hi-Trash:	Test A:
Medium	Medium	Medium	Slow
6	6	9	8
Boost	Normal	Quiet	Normal
55	45	40	50
8	9	8	10
15	14	8	16
9	7	6	8
Normal	Normal	Inverted	Normal
Medium	Fast	Slow	Medium
Off (All Metal)	Off (All Metal)	7	Off (All Metal)

The **Function Select** control scrolls through a list of functions.

Title
Indicates what type of function you are viewing (universal or mode dependant).

Functions
There are two types of functions, universal functions (under the *Main Menu* heading) and mode specific functions (under the *Search Mode* heading).

Navigation Arrows
Indicates which way the menu can scroll.

Function Setting

New Value Icon
Indicates the value for this function has been changed from the Factory Preset.

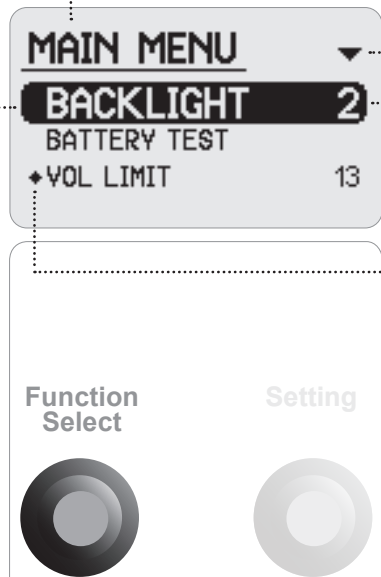

Once a function has been selected the **Setting** control accesses a settings adjustment screen.

Navigation Arrows
Indicates which way the setting can be adjusted.

Function

Function Setting (Visual Scale)

Function Setting (Numerical)

Factory Preset Indication
Indicates current setting as a Factory Preset.

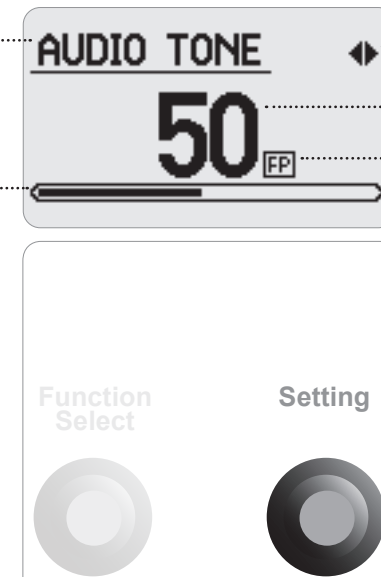

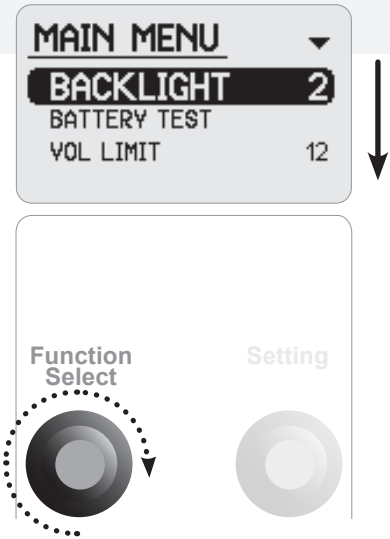

Turn the **Function Select** control right to scroll down the list. The currently selected function is highlighted.

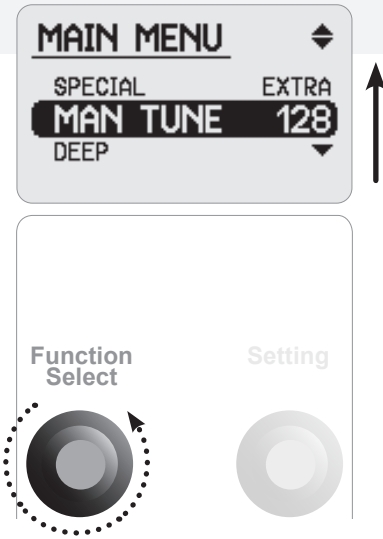

Turn the **Function Select** control left to scroll up the list. The currently selected function is highlighted.

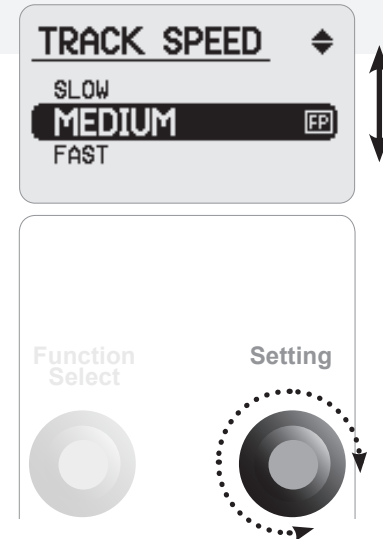

With a function highlighted turn the **Setting** control to the left or right to adjust the setting.

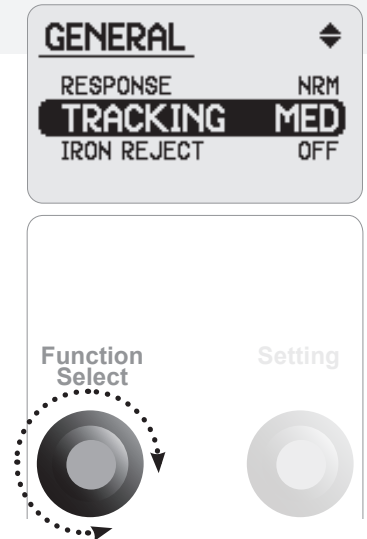

To return to the list of functions turn the **Function Select** control left or right.

The *Main Menu* **MAIN MENU** ▾
 BACKLIGHT 2
 BATTERY TEST
 VOL LIMIT 12
 GB TYPE GEN
 SPECIAL EXTRA
 MAN TUNE 128
GENERAL ▾
 MOTION SLOW
 RX GAIN 8

The functions for each of the six *Search Modes* **GENERAL** ▾
MOTION SLOW 8
 RX GAIN 8
 AUDIO NRM

DEEP ▾
 MOTION V SLOW
RX GAIN 9
 AUDIO DEEP

PATCH ▾
 MOTION MED
RX GAIN 6
 AUDIO BOOST

HI-MINERAL ▾
 MOTION MED
RX GAIN 6
 AUDIO NRM

HI-TRASH ▾
 MOTION MED
RX GAIN 9
 AUDIO QUIET

TEST A ▾
 MOTION SLOW
RX GAIN 8
 AUDIO NRM

G Deep Custom Custom Custom

Range **Off, 1-8**
 Factory Preset **2**



In low lighting conditions the LCD can be backlit. You can select how long the backlight stays on for once activated. Between settings one and six the time-out period is in increments of 10 seconds.

- 1 – 10 seconds
- 2 – 20 seconds
- ↓
- 6 – 60 seconds
- 7 – 120 seconds
- 8 – Always On

The time-out period is the length of time that the light will stay on after the last alteration is made on either Function Select or Setting control.

The light will come on again as soon as either control is moved.

If you are detecting in normal daylight you can select OFF to preserve battery power.

Range **0-8.0V**
+8.0V

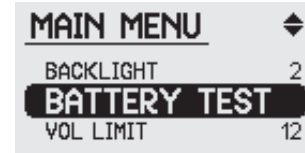

The Battery Volts screen allows you to view the current voltage of the battery. This screen can be viewed at any time.

When the battery is low a series of alarm signal pulses are given at one minute intervals.

Note: The Battery Test screen will automatically return to the list of functions after seven seconds.

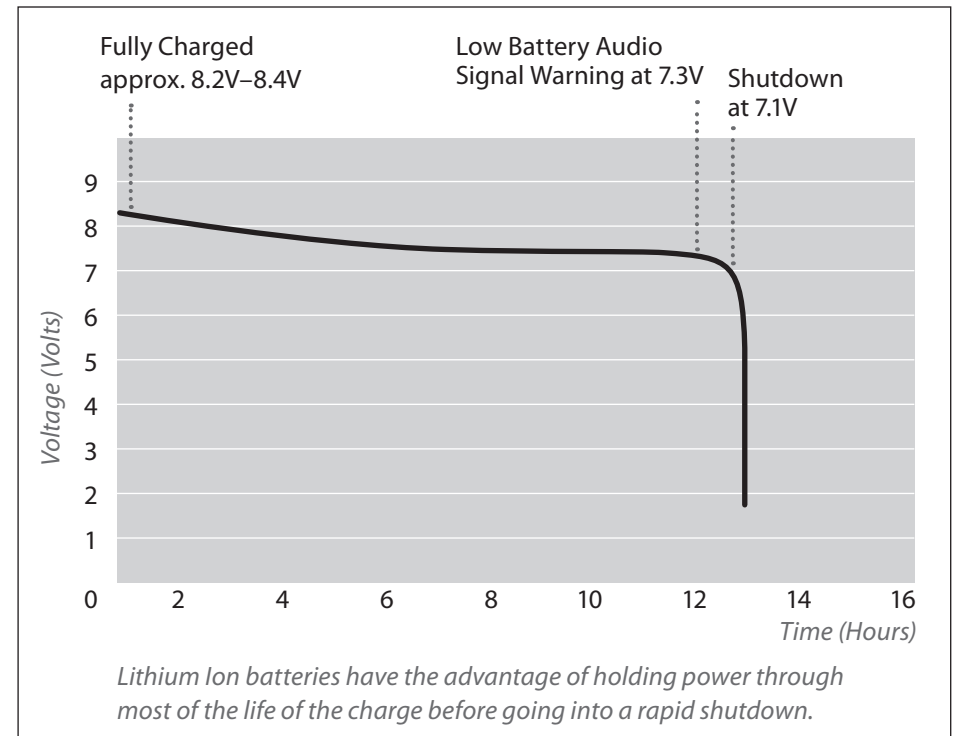

Volume Limit

Setting the Maximum Volume of all Sounds

Range
Factory Preset

1-20
12



Volume Limit is the maximum level of sound emitted by the detector when a target is detected.

If the Volume Limit is set to maximum all target signals will be heard, and will sound proportional to the target size and depth. Maximum limit allows you to hear the difference between a small and large target, but may be uncomfortable to your hearing if a large target is found close to the coil.

If the Volume Limit is set to half-way the target signal is unaffected for a small target but limited for a very large target.

If the Volume Limit is set to minimum most target signals will potentially be very limited. A low volume will be more comfortable on your hearing but will increase the risk of missing small targets.

Try using a large and small target to adjust the Volume Limit to a comfortable level.

Note: The Threshold may need to be reset if adjusting the Volume Limit to a low setting.



Caution: The detector is able to produce an extremely high volume if a large or shallow target is located.

Protect your ears!

The Volume Limit may need to be re-adjusted when switching between headphones and an external speaker.

Maximum Volume Limit:
Faint and loud signals are unaffected.

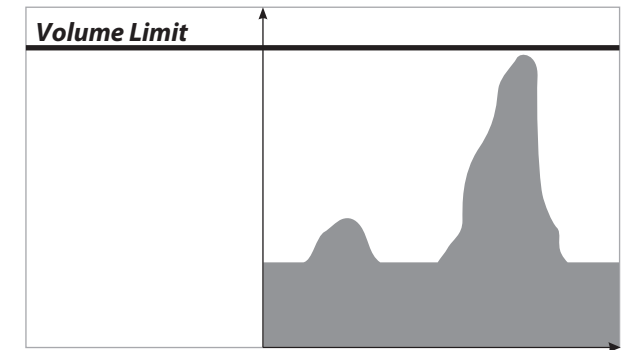

Mid-Range Volume Limit:
Faint signals are unaffected but loud signals are limited.

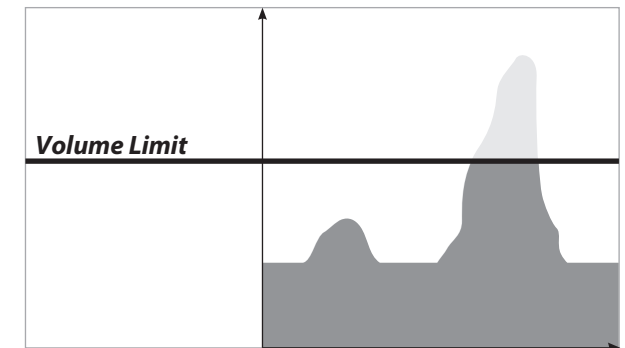

Minimum Volume Limit:
Both loud and faint signals are reduced to quiet levels.

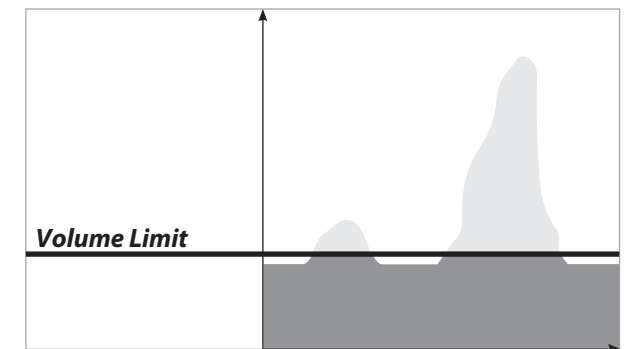

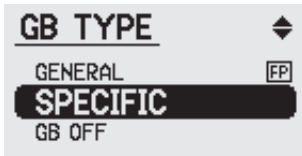
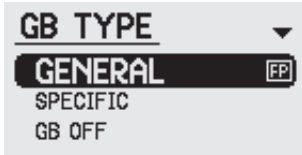
Range
Factory Preset**General, Specific, GB Off**
General**General**

This is the best Ground Balance Type for use in over 90% of goldfield soils and uses the conventional automatic Tracking as found on the previous Minelab models. In Tracking, General Ground Balance (GB) samples variations in the ground mineralisation and sets a continuously changing average of the Ground Balance level. General GB is ideal for most mineralised grounds and is the preferred Ground Balance Type for soils which have highly variable mineralisation.

Specific

This is a special Ground Balance Type for use in areas of highly magnetic, iron-rich soils. Use of Specific GB will allow you to keep the coil closer to the ground, and allows Monoloop coils to be accurately ground balanced in areas normally too 'hot' for their use. The Tracking function in Specific is more conservative than in General, and will pause on even the faintest response, removing the risk of 'Tracking out' faint signals.

It is recommended that you be more active in checking your GB setting when using Specific in variable soils. Stop periodically, raise and lower the coil, listen to any variations and re-ground balance where necessary. Ideally, Specific GB should only be used in soils that are reasonably uniform or non-variable.

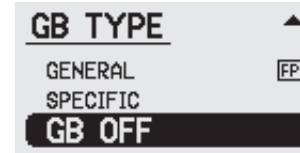
**GB (Ground Balance) Off**

In very benign soils, such as non-mineralised loam or sand, there can be very little and sometimes no ground effect. These areas are quite rare but are identified when your ground balance doesn't appear to be doing anything. By switching the GB Type to GB off you will achieve improved depth and sensitivity.

This feature will most likely be used by beach hunters, or inland treasure/relic seekers, as it is extremely rare to encounter a spot in the gold field where GB is not required.

Procedure:

Raise the coil off the ground, away from metal objects, and switch to GB Off. After the tone is heard you can commence detecting.

Note: To use the Iron Reject function (pg. 80) you need to operate in General GB Type.

When moving to a new area the first Specific Ground Balance must be done with the Ground Balance switch — not the Quick-Track button.

- 1 Find a clear area of ground without any targets.
- 2 Select Specific in GB Type in the Menu.
- 3 Change Ground Balance switch to Fixed.
- 4 Hold the coil 300mm–450mm (12"–18") above the ground.
- 5 Change the Ground Balance switch to Tracking. You will hear a high pitched tone that only lasts one second.
- 6 When the low pitch tone begins immediately start lowering and raising the coil over the ground. Try to lower the coil parallel and as close to the ground as possible without touching it. Continue moving the coil up and down until the audio has stabilised and any ground noise has stopped. When there is no longer a change in the Threshold the detector is 'Ground Balanced'.
- 7 Change the Ground Balance back to Fixed and commence detecting.

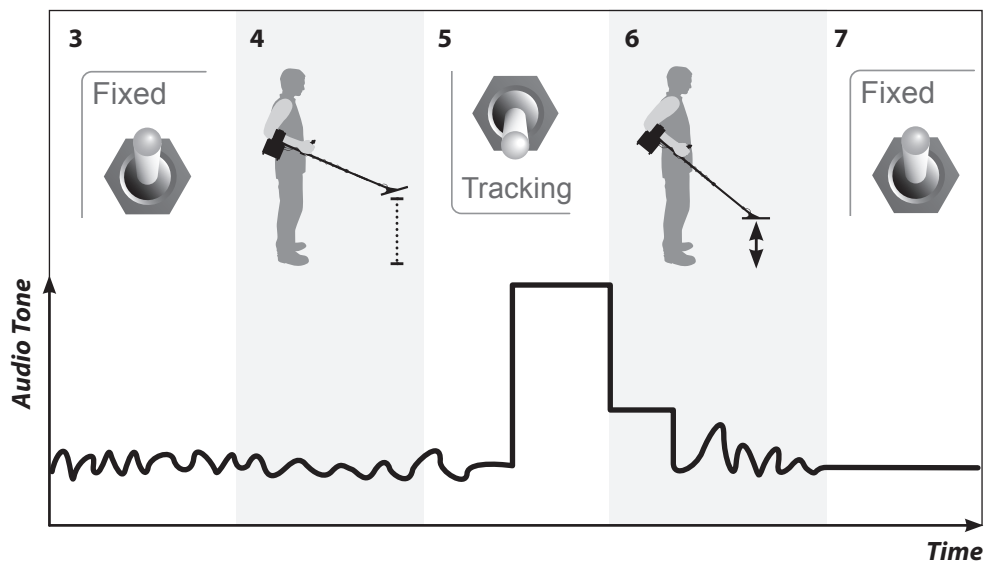

Range
Factory Preset

**Salt-Coarse, Sens Extra, Sharp, Sens Smooth
Sens Extra**



You can select which timings will be activated by the Special switch on the control panel.

Salt-Coarse

The effect of alkaline salt mineralisation is vastly different to the effect of ironstone and mineralised clays. Anyone who operates on dry salt flats will know how difficult they can be to detect. Normal should be tried first in these areas, but if the Threshold is too unstable then better performance will be obtained in Salt-Coarse.

Using the Salt-Coarse timing may result in a slight loss in signal response to smaller targets. However, the response on larger items remains relatively unaffected and ground noise is usually minimised. Therefore, when searching for large deep nuggets in highly mineralised soil, the Salt-Coarse timings can be used to obtain a smoother Threshold allowing you to hear those mellow deep nugget signals.



Sensitive Extra

This timing may increase the signal from certain hot rocks near the surface, but can actually help smooth out the Threshold in certain ground types; particularly with Double-D coils. In mild ground conditions Sensitive Extra will provide the best signal response on a small, deep target.

(Auto Tune, pg. 33)

Range | **0-255**



Sharp

Sharp is similar to Normal but it puts out a more powerful detection field. It is capable of an improvement in depth, but it is more susceptible to interference and will also increase the severity of false signals in difficult grounds.

This timing is best used in quiet conditions and can work well in combination with Deep Search Mode; with a reduced Rx Gain setting. Sharp is an excellent tool for pinpointing faint signals due to the very "sharp", aggressive signal response.

Choose Sharp in the menu and select it by switching into Special on the front panel.

Note: Sharp will work best with DD coils in most gold field locations.



Sensitive Smooth

Sensitive Smooth is optimised for an improved response on smaller, shallow nuggets in severe soils. There is a slight loss of depth on bigger targets; so you should not use this setting when seeking out large, deep nuggets.

Sensitive Smooth allows the use of monoloop coils in highly mineralised areas. It eliminates most false signals from hot rocks, and ground mineralisation, whilst retaining excellent sensitivity to small targets.

Note: Sensitive Smooth is best suited for use with monoloop coils in difficult soils.

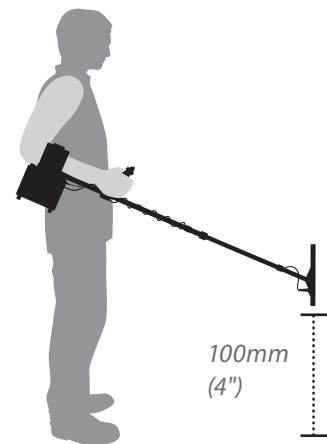

Note: A slower Motion speed (pg. 66) will also reduce instability due to interference.

Manual Tune allows you to scroll through and select a particular channel.

Manual Tuning through the full range is time consuming. We recommend that you use the Manual Tune for fine adjustments after performing an Auto Tune (pg. 33).

You may find that you can select a channel at one end of the scale, or the other, if detecting in a quiet area with no interference. Low numbers are lower frequency channels and high numbers are higher frequency channels. High frequency channels can be slightly more sensitive to smaller targets close to the surface. Low frequency channels can give a little more depth to larger targets, but the difference is only marginal.

- 1 Hold the coil vertical and 100mm (4") above the ground making sure there are no large targets or obvious electrical interferences close by.
- 2 Access the Manual Tune screen via the menu.
- 3 Slowly increase or decrease the numbers, pausing after each change to test the stability.
- 4 Listen to each channel in the range until you hear the least noise.

Note: If interference persists after tuning try reducing the Rx Gain setting, but in high interference areas you may need to use Cancel on the Coil/Rx switch.

If the setting control is turned quickly you will notice noise caused by rapid movement through the channels. This is normal and will not be present when the control is turned slowly.

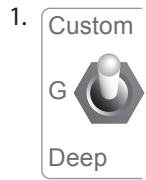

Search Mode gives the operator access to a number of detecting modes to use under different circumstances. Deep and General Modes are two of the positions on the switch and the third position is Custom, which allows the operator to select one of the four search modes from the menu.

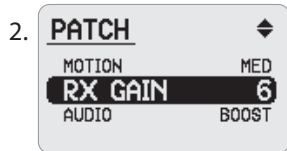

To select the preferred Custom Search Mode:

1. Place the Search Mode switch into the Custom position.
2. Using the Function Select control, scroll through the menu to the Custom Mode, e.g. Patch.
3. Using the Setting control locate the desired search mode, e.g. Hi-Mineral.
4. Turn the Function Select control in either direction to lock in your selection.
5. You can now scroll down and see what settings are in place for Hi-Mineral.

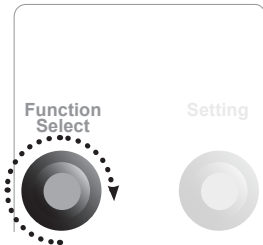

Search Mode is user configurative; allowing you to setup the detector to suit your detecting style and location. For example, you may wish to create a Pinpointing Search Mode and select this for your Custom Search mode., then while detecting in General or Deep, you can quickly change to Custom to pinpoint a target.

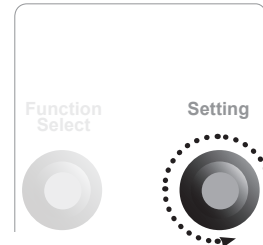

Tip: If you wish to quickly compare settings you can change the search mode switch on the front panel between Deep, General and your Custom selection, while looking at the functions displayed on the LCD.

Editing Personal Search Modes

You can create your own personal Search Modes for different locations, targets, coil sizes, etc. All functions displayed under the Search Mode name in the LCD menu are Search Mode specific, allowing you to save different settings for each mode.

Choose the Search Mode you wish to edit and select new settings for any functions you wish changed. All changes are automatically saved when the detector is switched off.

You can assign one of the 14 different names, from the Custom Name list (pg. 82), to each of the four Custom Search Modes.

Range

Very Slow, Slow, Medium, Fast



The speed at which you sweep the coil has an effect on target response time and Ground Balance adjustment. Matching your preferred coil sweep speed with the corresponding Motion setting can reduce noise and improve target signal responses.



Very Slow and Slow
When carefully detecting a small area a Slow Motion setting will allow for maximum stability; ensuring good depth and sensitivity to small targets. For maximum performance a very slow and steady coil sweep needs to be employed when using the slow motion options. Very Slow Motion can be used in combination with a higher Gain and Deep or Boost Audio Type to achieve maximum performance.

Medium
This motion setting is ideal for general detecting when normal 'slow & low' techniques are being used. Medium will improve sensitivity to small targets while detecting with a moderate sweep speed.



Fast
Fast Motion is useful when using a fast sweep speed to cover ground quickly. In these circumstances, a quick sharp target response is used to alert the operator to a target. Fast will allow you to cover more ground in a shorter amount of time.

Note: The Motion speed also effects how susceptible the detector is to external interference. Basically, the slower the Motion speed the less interference you will get; resulting in a smoother Threshold.

If you are using a Fast Motion and the Threshold is too unstable you can either select Quiet Audio Type (pg. 68) or reduce Rx Gain (pg. 67).

Range

1-20



The Rx Gain function allows the GPX-4500 to be optimised for differing conditions; controlling the sensitivity of the detector to its environment and targets.

With a high Rx Gain setting the detector will pick up smaller and deeper targets, but may respond to unwanted noise and ground signals. A high Rx Gain setting is recommended for mild soil conditions and areas of low interference.

With a low Rx Gain setting the detector will pick up less unwanted noise and ground signals, but may miss deep targets. A lower Rx Gain setting is preferable for variable, 'noisy' conditions or high interference areas.



Note: Be prepared to reduce the Rx Gain setting if the background threshold is erratic. A smooth threshold is preferred, as a lot of noise will drown out a soft signal.

The Rx Gain control should be adjusted to suit the soil conditions and the coil being used. For example, if you have found some nuggets in an area and wish to detect the same spot with a larger Monoloop coil it may be necessary to reduce the Rx Gain setting.

Always ensure the detector is properly ground balanced, and tuned, before making any changes to the Rx Gain setting.

Tip: Try using a slower Motion setting (pg. 66) to allow a higher Rx Gain setting.

When using the Coil/Rx switch in Cancel (pg. 44) a higher Rx Gain setting may be possible.

Audio Type

Changing the Audio Response of Target Signals

Range

Quiet, Normal, Deep, Boost



The Audio Type function replaces the Boost switch on the GP series detectors. There are four options to choose from. Each setting changes the way that the detector interprets a signal and how that signal is produced as an audio response.

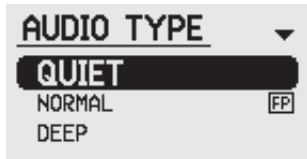

Quiet

This setting gives the most reduction of both ground noise and interference. The signal response is slightly quieter compared to the other Audio Types. Quiet should only be used in the most extreme situations.

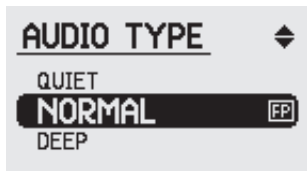

Normal

This may be used for general detecting conditions. Normal provides the best compromise for signal response and Threshold stability.

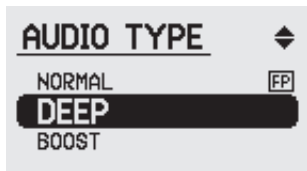

Deep

This setting is the preferred Audio Type when searching for larger targets at depth. It works well in combination with the slower Motion options where target signals come through loud and clear, but noises from the ground and electrical interference are somewhat filtered out.

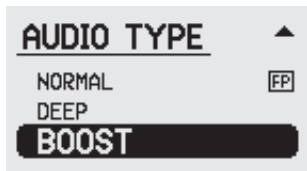

Boost

This is a more aggressive Audio Type. Boost will provide very sharp target signals but will also increase any signal caused by ground noises or electrical interference. It is best used in milder soils and well away from electrical interference.

Note: Each Audio Type will have a different optimum Rx Gain setting so you should check the level of Rx Gain if you make changes to Audio Type.

Audio Tone

Adjusting the Pitch of the Threshold of the Threshold

Range

1-100



Audio Tone is the pitch of the Threshold emitted by the detector.

Large, deep targets produce a different response to small, shallow targets. It is important to adjust the Audio Tone to suit the type of target you are searching for.



A high Audio Tone setting may help identify small targets from ground signals, but a low Audio Tone setting may allow deep target signals to stand out.

You may find that you hear targets better in a particular range of Audio Tone. To produce the most audible target signal for your hearing try using a large and small target to adjust the Audio Tone.

Range

1-20

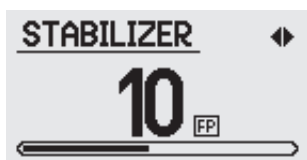

Note: Regardless of which Audio Type is selected, the optimal position of the stabilizer is one number below the point where the threshold begins to chatter.

The Stabilizer function controls the point at which faint variations in the Threshold begin to be heard. These faint variations can either be ambient noise or faint target signals. As you increase the Stabilizer control faint signals will become louder but the noise level will also increase. This may potentially hide a desirable target signal. The Stabilizer allows you to mask faint variations, to provide a perfectly stable Threshold, improving your ability to identify faint target signals.

The Stabilizer is best left in the Factory Preset position until the soil conditions are determined. Once the Rx Gain level has been set for the local conditions, and other audio settings have been selected, the Stabilizer can then be used to fine tune the Threshold stability.

To find the optimal position of the Stabilizer ensure the coil is being swept across the ground. One number below the point at which the Threshold begins to chatter is generally the best setting.

Tip: By turning the stabilizer control close to minimum (<3) the threshold will be very stable, but you will lose a lot of sensitivity to smaller targets. This can be a desirable feature in certain scenarios, such as looking for large nuggets in a high-trash area, or using the GPX-4500 to search for coins or treasure.

The effect of the Stabilizer could be seen as having a similar effect to that of the Rx Gain control. However, the Stabilizer effects the audio processing only and does not change the Receive (Rx) signal, so it should be used as a final stage fine tune.

After making any adjustment to the Stabilizer, if the ground conditions change or you wish to change coils, you may need to reset the Rx Gain. Before doing so return the Stabilizer to the Factory Preset setting. This will ensure you select the most appropriate Rx Gain level to suit the conditions and then you can fine tune the Stabilizer.

Tip: We recommend the best order for setting these controls are:

1. Select an appropriate Search Mode
2. Select the desired Audio Type
3. Adjust Rx Gain until the threshold starts to break up
4. Adjust Stabilizer to smooth out the threshold.

Signal Peak

Adjusting the Pitch Variation of Target Signals

Range

1-20

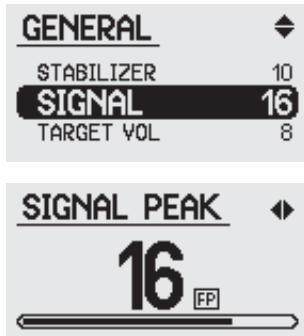

You are more likely to hear a target signal when both the volume and the tone of the target signal change upon detection rather than the volume alone.

A target signal on the GPX-4500 is normally a two-tone signal. A target signal which first falls in pitch and then rises is normally a deep target. A 'rise and fall' of the pitch characterises a small target.

The Signal Peak control sets the level of variance between the high and low pitch of the signal.

A **high** Signal Peak setting will increase the pitch variation of the target signal. However, in highly mineralised ground this high variance of signal may make the detector appear noisy.

A **low** Signal Peak setting will decrease the pitch variation so target signals will sound more monotone.

Note: People who suffer high frequency hearing loss may prefer to use a Signal Peak setting of 10 or less.

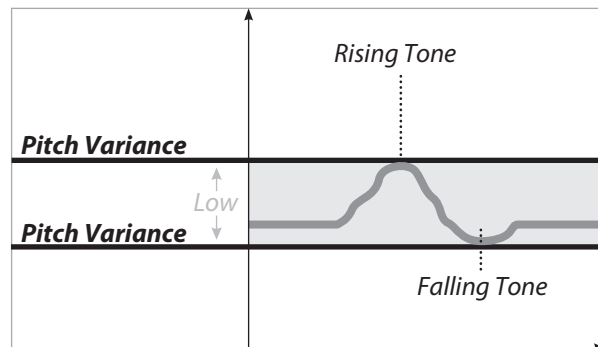
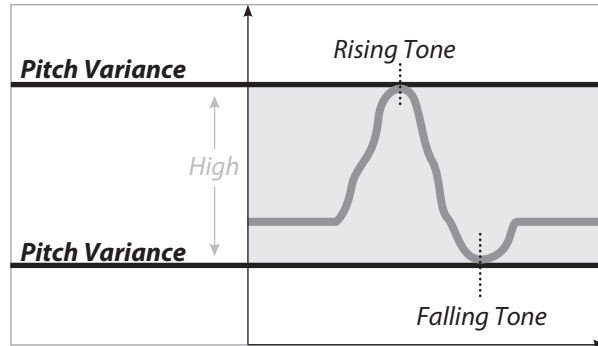

Target Volume

Range

1-20

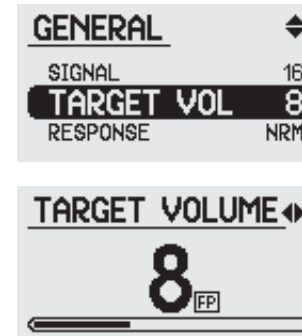

Target Volume

The Target Volume controls the strength of target signals and at settings above 8 it will slightly increase the volume of the threshold as well. This is useful for very windy conditions, people suffering from hearing loss, or when using external speakers. With the audio amplifier built into the Li-Ion battery pack you can plug a speaker directly into the battery, and set an appropriate level of amplification using the Target Volume.

Be aware when switching from headphones to an external speaker; you may need to make minor adjustments to your Threshold (pg. 34) and Volume Limit (pg. 56) controls.

Tip: A lower Target Volume is recommended in high trash areas.

The Target Volume can be used as an Audio boost in quiet conditions and can also be used to reduce, or smooth out, ground noise signals in highly mineralised soils. This is a powerful feature and will work in conjunction with the Stabilizer control, giving you the ultimate in fine tuning ability. A bit of experimenting may be required to find the optimum combination in different conditions.

Note: If you are using the Target Volume to control ground signals and adjustments to the Rx Gain are required (due to a change of coil or location), make sure the Target Volume is returned to the Factory Preset setting first. You can then fine tune to suit the new conditions.

Inverting the Pitch of the Target Signal

Range

Normal, Inverted

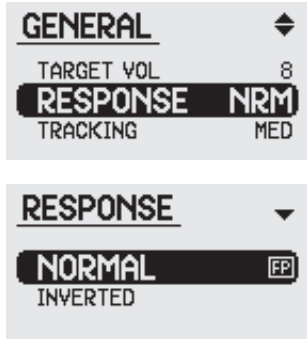

The Response function allows you to invert the normal pitch combination of target signals to different size targets.

Normally, a large/deep target has a falling-then-rising tone sequence. If you prefer a rising-then-falling tone sequence (the same as small/shallow target responses) for large/deep targets, use the Response function to invert the pitch.

Normal

When Normal is selected and a small target is detected the pitch normally rises to a higher pitch and then falls to a lower pitch. When a deep/large target is detected the pitch normally falls and then rises.

Inverted

When Inverted is selected and a small target is detected the pitch will first fall to a lower pitch and then rise, and a deep/large target will first rise in tone and then fall.

Response is a personal preference and is quite dependant on your hearing.

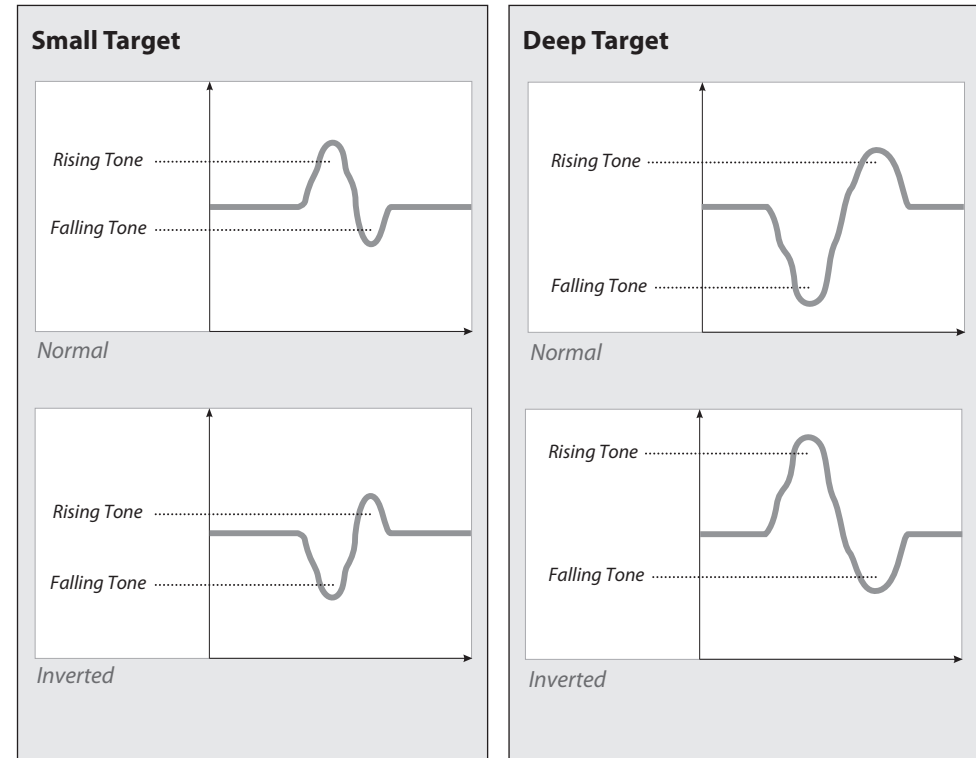

Range

Slow, Medium, Fast

Tracking Ground Balance is the preferred setting when searching in highly variable mineralisation. Tracking Ground Balance automatically adjusts the Ground Balance, as necessary, to maintain stability and detection depth. The speed of the Tracking can be changed to suit the degree of variable mineralisation.

The GPX-4500 has three Auto Tracking Speed options: Slow, Medium & Fast.

The preferred Tracking Speed is the slowest speed which keeps up with the variability of the ground mineralisation. You should gradually increase from Slow Tracking Speed, Medium Tracking Speed, then Fast Tracking Speed as required.

Slow

The Slow Tracking Speed is recommended if seeking out large, deep targets in variable ground, but you should check your ground balance often and re-balance (pg. 41) whenever necessary.

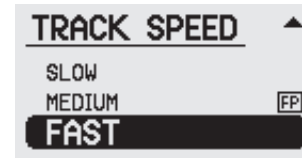
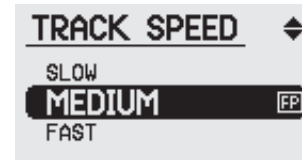
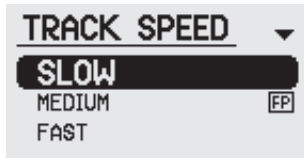
**Medium**

In ground conditions which make operating in Fixed impractical, the factory preset Medium setting provides a good compromise between effectively maintaining the Ground Balance and pausing the Ground Balance when a target is located.

Fast

The Fast Tracking Speed is very effective at adjusting the Ground Balance in highly variable soils. Its use will only be required in extreme cases.

Coils with Tracking

When using a Monoloop coil the nature of the Tracking tends to be more aggressive. Faint, deep targets may be 'tracked out'. In extreme, highly variable, soil types you may achieve better performance by opting to use a Double D coil instead of a Monoloop, and then selecting the most appropriate Tracking Speed.

Initial Very Fast Ground Balance

Every time you switch from Fixed to Tracking on the front control panel, or via the Quick-Trak button, the GPX-4500 will initiate a very fast auto Ground Balance. The Tracking Speed does not affect the speed of the initial very fast auto Ground Balance.

Range

Off (All Metal), 1-10

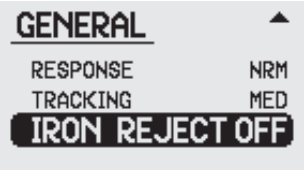

The GPX-4500 is capable of rejecting many ferrous (iron) targets while still detecting non-ferrous targets.

While detecting in littered goldfields much of the shallow iron rubbish may be ignored with a high probability that valuable targets will not be missed.

When Iron Reject is turned off no iron targets will be rejected. Therefore, all types of metals will produce a target response. This is known as 'All Metal' and is the preferred setting for most situations.

In All Metal the detector will give varying volume and pitch signals. This information does not indicate the type of metal in the object.

If you are Pinpointing a target prior to digging, the best results will be obtained with Iron Reject Off.

Note: When a target has been located the coil should be passed back and forth over the target centre several times. Remember to set Ground Balance to Fixed for this and keep the sweep across the target at an even height and as close to the ground as possible.

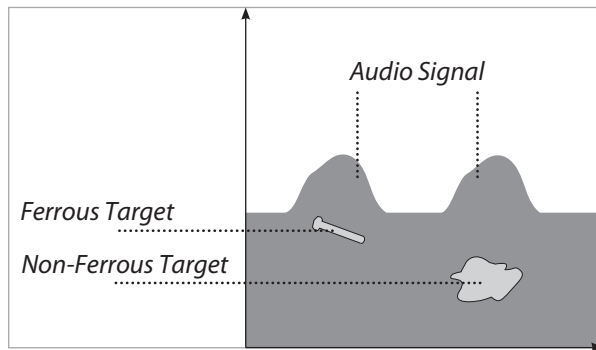

All Metal

Tip: To improve discrimination accuracy you should always test the target from at least two directions (90° to each other) so that the detector 'sees' the target from different profiles.

When Iron Reject is activated the detector rejects ferrous objects by blanking the normal target signal. You will notice the Threshold tone goes silent as the coil passes across the ferrous target.

Discrimination is dependent on target signals being strong enough for the GPX-4500 to determine if the target is ferrous or non-ferrous. If the signal is weak the detector will give a non-ferrous response until the signal becomes stronger, i.e. due to a hole being dug and the coil getting closer to the target. The Iron Reject function is designed this way to allow maximum accuracy, while limiting the chances of rejecting a desirable target.

You can choose less cautious levels of discrimination for appropriate areas. Possibly there is a mining camp that has not been detected due to the high level of rubbish. Iron Reject now gives you the ability to increase the amount of rejection while knowingly accepting more risk of rejecting a low grade nugget.



Caution: Do not attempt to discriminate by raising and lowering the coil on a deep or partially dug target. An accurate discrimination requires an even side-to-side coil motion. It is recommended to dig all targets that do not give an obvious rejection.

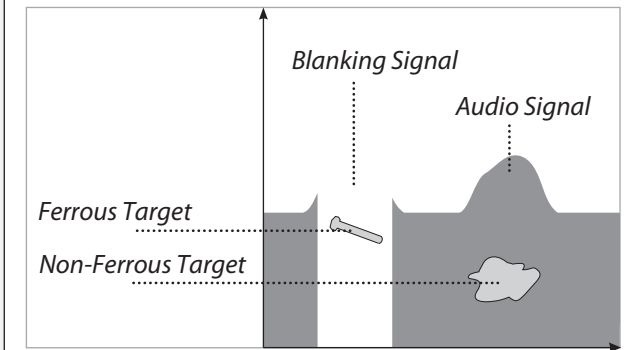

Discrimination / Blanking

Range

Off (All Metal), 1-10

Not all targets are clearly ferrous or non-ferrous. A lot of targets could be described as 'maybe' ferrous. Which of the 'maybe' targets that the detector identifies as being ferrous is controlled by the Iron Reject level. The low numbers use more caution and will identify most 'maybe' targets as non-ferrous. As the Iron Reject level is increased less caution is used so that high Iron Reject levels will identify more 'maybe' targets as being ferrous.

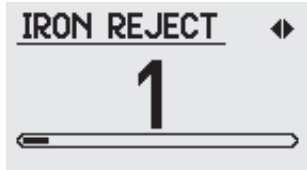

A low level of Iron Reject will keep the discrimination conservative. 'Maybe' targets will respond with a normal non-ferrous signal and only definite ferrous targets will cause the Threshold and target signal to blank. If the target response is too weak for accurate discrimination the detector will give a normal target signal until you dig closer to the target and the signal strength improves.

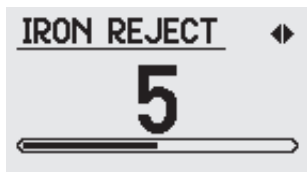

A medium level of Iron Reject is less conservative and will enable you to reject more ferrous targets from non-ferrous targets; yet it will not 'blank' or reject most gold nuggets.



A high level of Iron Reject is very aggressive, but very effective at blanking ferrous targets. With a high setting some small desirable targets (e.g. gold coated in ironstone) could be mistaken as a ferrous target. This setting should only be used in very high trash areas, or when using the detector in lower mineralisation when searching for coins and relics.

Tip: Iron Reject will give the best results when used in combination with the specially designed GP series, or Commander DD coils, and will not work when using Monoloop coils.

Note: The Iron Reject function will not work accurately with the Coil/Rx switch in the Mono or Cancel positions.

A low level of Iron Reject requires a stronger ferrous signal before discrimination occurs. Very weak ferrous target responses will give normal 'all metal' type signals. A high level of Iron Reject will cause blanking on weaker ferrous targets.

Select the level of Iron Reject depending on how cautious you want to be and how much trash is in the area.

If the area is heavily littered, you may want to be less cautious and use a higher level of Iron Reject. If there is little trash in the area and it is mostly close to the surface you may prefer a more conservative, low level of Iron Reject.

It is usually best to recover all targets, especially when you are on a known gold producing site or a successful patch. However, careful use of the Iron Reject feature can be rewarding in areas other operators have avoided.

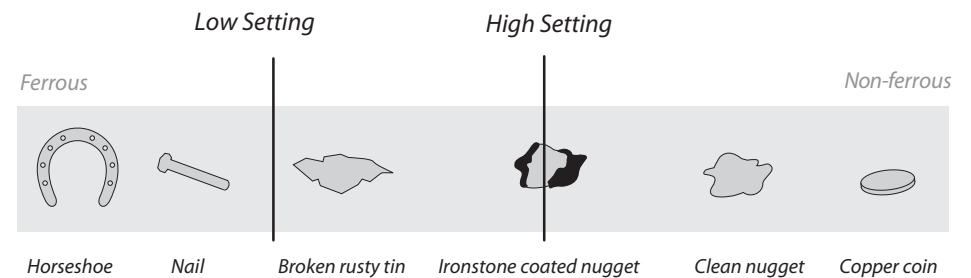

Caution: Iron Rejection will only work when in General and Fixed Ground Balance, but best results will occur in Fixed Ground Balance.

Custom Names

Patch
Bedrock
Pinpoint
Gridding
Diggings
Salt Lake
Hi-Mineral
Lo-Mineral
Very Deep
Shallow
Hi Trash
Beach
Test A
Test B

When creating your own custom mode, in one of the four Custom Search Mode options, you can personalise the mode by selecting a name from the list.

For example, if you regularly detect in exposed bedrock you can set your own Custom 'Bedrock' Search Mode:

1. Select Custom on the Search Mode switch (located on the front panel).
2. Scroll down the menu and a Search Mode will be highlighted, e.g. Patch.

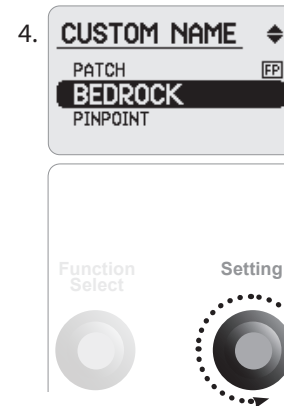
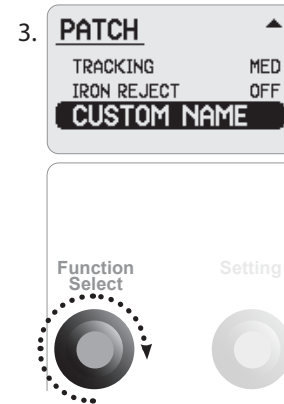
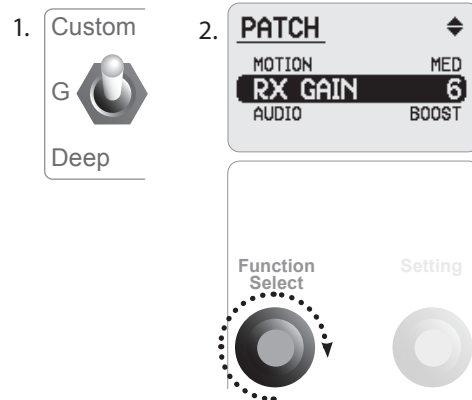

3. Scroll to the bottom of the menu until you see Custom Name.
4. Using the Setting knob scroll down until 'Bedrock' is selected, then move the function knob to apply the name change.
5. The Search Mode name is now Bedrock and any mode specific setting changes you make are automatically saved when you switch the unit off.
6. You can now switch between Deep, General and Custom/Bedrock via the Search Mode switch on the front panel.

Note: Even when doing an All Settings Factory Reset your Bedrock, or other Custom Modes, settings are still preserved.

Pinpointing

Locating the Target

Note: Accurate pinpointing is also important to prevent damage to the buried object, which can significantly reduce its value.

To find an object, and reduce the size of the hole required to remove it from the ground, it is necessary to pinpoint the exact location of the object.

If a target is heard, first confirm it by setting an accurate Ground Balance away from the target. To Ground Balance, if detecting in Fixed position, hold down the Quick-Trak button and pass the coil around the area of the target, making sure the target is not detected (keep the coil well away from where the target is). Once completed release the button.

If detecting in Tracking, move the coil slowly around the area of the target keeping well away from the target itself. Hold down the Quick-Trak button to go to Fixed and pinpoint across the target.

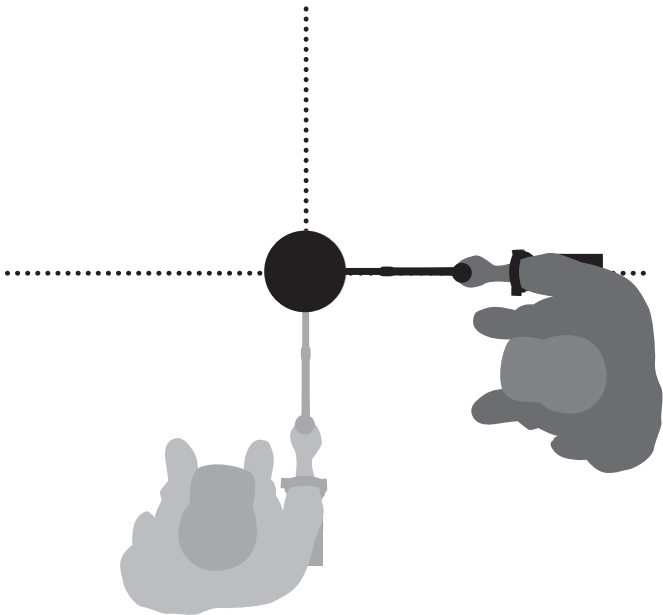

Tip: If detecting on loose dirt or gravel you can actually draw the lines using your shoe or pick.

To pinpoint a detected target sweep the general area with the coil taking note of where the strongest signal is received.

By shortening the length of the sweep it should be possible to draw an imaginary line in the ground where the strongest signal is located.

Line up the target at 90° from the initial direction and repeat the process. The object is located where the two imaginary lines cross.

Note: With the Coil/Rx switch set to Monoloop or Cancel, when using a DD coil, pinpointing will not locate a target in the centre of the coil; the target will be slightly to the left. The left edge of the coil can be used to pinpoint shallow targets.

Double-D Setting

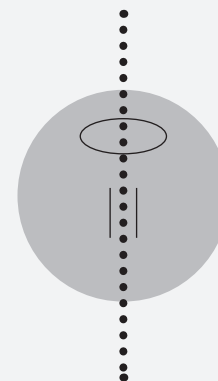

Strongest Signal

Monoloop (M) Setting (with DD coil)

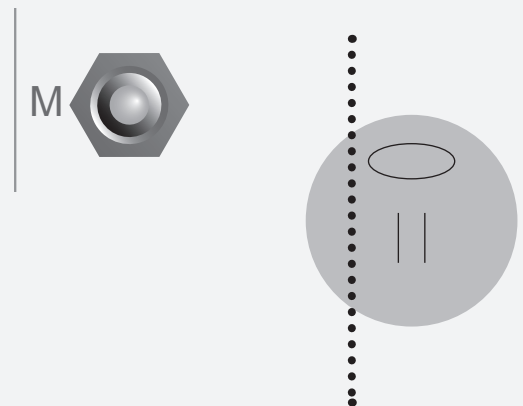

Strongest Signal

It is essential to carry at least one of the following digging tools with you while detecting:

- a pick with broad scraping blade (essential)
- a crowbar (for very deep objects in hard ground)
- a small, strong digging spade or shovel (for soft soils, sand, etc.)



Back-fill Every Hole You Dig

Always refill any holes, and scatter leaves and surface debris, before leaving the area. Help restore the area to its original condition to help give electronic prospectors a good reputation, and also disguise your secret hot-spot! Any rubbish you recover should be taken away with you and disposed of properly.

Refilling holes and removing rubbish will help detector users maintain a good reputation. This should lead to more areas being readily accessible for prospecting.

Note: When digging, avoid sharp edges to the hole as they can produce false signals, potentially masking the target. Slope the edges of the hole to avoid any problems.

Note: Your hands and wrists must be free of any metallic jewellery and watches when passing dirt over the coil.

Note: The GPX-4500 is a 'motion' detector. This means it must be moving over a target to detect it.

- 1 Clear the area of loose surface material and check that the target signal is still there. If it is not, the target should be amongst the moved surface material.
- 2 Remember if there are other signals close to your target. This is important so when you come to dig your hole you do not heap the loose dirt on top of another target already in the ground.
- 3 If the target signal is still present use your pick to dig to a depth of approximately 50mm (2").
- 4 Sweep the coil over the hole to determine if the target has been dug. If the target signal is not heard then the target should be in the pile just dug. Otherwise dig a little deeper and check again.
- 5 Start digging approx. 100mm (4") in front of the target to reduce the chance of damaging it. Damaging a nugget may reduce its value.
- 6 If the target signal disappears from the hole sweep the coil over the loose dirt and pinpoint its exact position.
- 7 Take a handful of the dirt and pass it over the coil.
- 8 If there is no signal place the handful carefully in a new pile, pinpoint the position of the target again, and repeat with another handful of soil.
- 9 Once the target is in your hand, transfer half of the dirt to the other hand. Test each handful of dirt across the coil.
- 10 If the target is too small to see drop the dirt onto the top of the coil and with your finger move any suspect objects. A target signal will only be given when the target is moved.

For Maximum Gold Recovery

Keep the coil as close to the ground as possible.

Listen carefully. This is more important than looking.

Slow down, do not rush, take your time.

Have a positive mind set and imagine a nugget at every next sweep!

Remember that covering a small section of ground thoroughly will be more productive than randomly searching a larger area.

Follow these hints and techniques to help you to utilise the power of your GPX-4500, to ensure that every trip is a success.

Identifying Target Signals

- Metallic targets will usually give a 'solid' sounding signal when the coil is swept across the object from any direction. A metallic target generally produces a short, sharp and mostly symmetrical signal. Ground noises usually give a broad uneven signal when the coil is swept from different directions and often may only give a signal from one direction and no signal on the return sweep.
- If you are not sure if the sound is ground noise or a target signal you should always investigate. Scrape a shallow hole about 30mm (1") deep over the suspected target. Sweep the coil over the hole at the original ground level. Do not dip the coil into the hole. If the signal has decreased in volume or is less defined it is probably ground noise. If the signal remains the same, or becomes louder, it is likely a metallic target. If you are still not sure make the hole deeper and repeat the process.
- A 'halo effect', which may be built up around a buried metal object, makes the object appear to be larger to the detector than it actually is. This will be reduced once the target is disturbed from its position in the ground (e.g. a small object, detected at a substantial depth, may be more difficult to detect once disturbed from the ground and lying in the loose dirt. If the object is re-buried the 'halo effect' will not be present).

Big Gold

Big gold at depth gives a much different response to the smaller shallower pieces. The signal is often quite broad, and there is very little pitch variance.

False Signals

If false signals are occurring as you sweep the coil, check that they are not produced by any metal that you are carrying, such as your pick, battery or steel toe boots.

Move the coil closer, and then further away from your body, in order to check if the signals are coming from these items. If they are, increase the distance between the coil and these items.

Avoid carrying metallic objects in your pants pockets as these are too close to the coil.

- Do not try to eliminate what might appear to be a faint, isolated ground noise by balancing the detector over the target; you may be 'balancing out' the target response from a deeply buried metallic target. It is better to Ground Balance around the target, without going across it, then switch to Fixed and try Pinpointing.
- Dig all target signals, even in previously detected areas. The GPX-4500 has superior ground balancing and depth so it is possible to find new targets in well-worked areas where other detectors have been unable to cope with the high degree of mineralisation and/or salt.
- In some goldfields a response may be received from a concentration of orange/reddish dyke material or clay. Remember, a metal target will get louder by moving the coil even centimetres closer.
- If detecting areas of extremely variable mineralisation detect along the ground contours rather than across them. This will often stabilise the effect.
- In heavily mineralised areas the operator may need to sweep the coil 10–20 mm (½"–1") above the ground. This should give a more stable Threshold and less ground noise.
- Very sudden or large changes in the mineralisation of an area may produce a signal from the detector. Usually this signal is very broad and often only present in one direction.

The GPX-4500 is supplied with the 11" Double-D coil. This coil has an excellent combination of depth, sensitivity and stability.

In addition to this there are also a number of other coils available to give improved performance to your detector. These range from smaller coils which give greater sensitivity to small targets, are lighter and more manoeuvrable in heavy vegetation, up to larger coils which give greater depth and improved ground coverage.



10" x 5" Elliptical Double-D

This is the coil every prospector should carry as its versatility is endless. Great in thick scrub, heavy mineralisation and high trash, it has superb sensitivity and surprising depth for such a small coil. It is also great for pinpointing deep targets found with one of the larger coils, and is extremely stable in all soils.



15" x 12" Semi-Elliptical Double-D

This coil has greater depth and ground coverage than the 11" DD and provides stable operation in all soils. This is a great coil for all round use in highly variable mineralisation and a lighter, more manoeuvrable alternative to the 18" DD when seeking out large nuggets in heavy mineralisation. Its semi-elliptical design provides impressive sensitivity for its size.

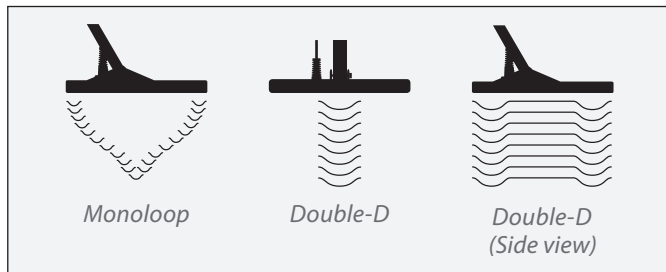

18" Round Double-D

A serious coil for the serious operator. The 18" Double-D punches deep through heavy mineralisation, while running smooth to allow you to hear those mellow, deep nugget responses.



8" Round Monoloop

The most sensitive of the Commander series, the 8" round provides the best depth on sub-gram nuggets in light to moderately mineralised soils. A popular coil for use on old diggings, it is also a great coil for detecting in heavy vegetation.



11" Round Monoloop

A lighter, more sensitive and deeper seeking coil compared to its Double-D brother, the 11" Monoloop is a brilliant coil for almost any situation. The second most sensitive Commander Monoloop, it is also one of the most stable Monoloop coils available and remains stable in most soil types.



15" x 12" Semi-Elliptical Monoloop

On larger nuggets, this coil has better depth than the 11" Monoloop and the 15"x12" Double-D. It is very sensitive for its size. This coil is great for searching open areas for new patches, and also when seeking out deeper nuggets in areas that are too vegetated to allow effective use of the 18" Monoloop. It is an extremely stable coil and runs smooth in all but the worst soil conditions. This coil has already become a favourite for many operators.

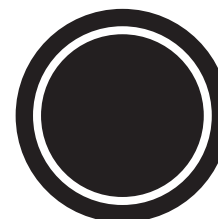

18" Round Monoloop

Superb depth and good sensitivity in low to medium mineralisation. This coil will find targets in heavily worked areas where other operators have given up.

Choosing the Right Coil for the Job

Note: In some circumstances non Minelab Double-D and Monoloop coils will work on the GPX-4500. However, there are limitations which mean some functions will not work properly. In some cases the use of coils not designed for the GPX-4500 may cause the detector to be unstable and noisy.

There are five main things you should consider when deciding which coil is best for your terrain and target:

Coil Size and Depth

A larger coil will typically find targets buried deeper in the ground but they can be less sensitive to smaller targets. A smaller coil is typically more sensitive to small targets, but does not go as deep as a larger coil.

Mineralisation

A Monoloop coil will often have improved performance over a Double-D coil but can be more difficult to Ground Balance and therefore possibly more noisy. A Double-D coil is often more stable in heavily mineralised areas.

Terrain and Vegetation







A small coil can be easier to manoeuvre through thick scrub or rough terrain. A smaller coil is also a lighter weight than a larger coil.

Discrimination

In areas where discrimination is required a Double-D coil is necessary for Iron Reject to work. In high trash concentrations a smaller coil is preferable.

Search Pattern

A Double-D coil will typically provide a 'blade-like' detection pattern from the toe to the heel of the coil, which gives excellent ground coverage. A Monoloop coil has a detection field that is typically cone shaped, which requires overlapping of sweeps to ensure thorough ground coverage.

	Small, Shallow Nugget	Large, Deep Nugget	Highly Mineralised	Less Mineralised	Open Ground	Heavy Scrub	Iron Disc.
10" x 5" Elliptical Double-D 							
15" x 12" Semi-Elliptical Double-D 							
18" Round Double-D 							
8" Round Monoloop 			✱				
11" Round Monoloop 			✱				
15" x 12" Semi-Elliptical Monoloop 			✱				
18" Round Monoloop 			✱				

 – The shaded areas indicate each coils recommended uses.

 – May operate well in Enhance or Sensitive Smooth timings.

No sound	<ul style="list-style-type: none"> • Check that the detector is on (battery, power cable, connections and LCD) • Turn the Threshold control fully clockwise • Turn the Volume Limit to maximum (20) • Check that the headphones are plugged in • Try using a different set of headphones or a different battery
Threshold but no target signal	<ul style="list-style-type: none"> • Try testing different coils with a known target
Random noise	<ul style="list-style-type: none"> • Ground Balance again • Re tune using the Auto Tune button • Set the Coil/Rx switch to Cancel • Reduce Gain • Move away from other detectors working nearby • Move away from thunderstorm build-up
Battery will not charge	<ul style="list-style-type: none"> • Check that there is power to the accessories socket using vehicle charger • Check the fuse in the 12V charger plug (M205–5A) • Check the battery LED patterns (pg. 20)
Battery not holding charge	<ul style="list-style-type: none"> • Try an alternative charger adaptor • Change the battery
'Coil Overcurrent' screen appears	<ul style="list-style-type: none"> • Turn the detector off, wait for a few seconds before turning it back on again

Control Box

This encloses the electronic circuitry of the detector. The control box generates the Tx (transmit) signals sent by the coil and processes the Rx (receive) signals detected by the coil. All functions are located on the front and rear panels of the control box.

Discrimination

The ability of a detector to determine if a located target is made from ferrous metal (iron or steel) or non-ferrous metal (non-magnetic).

Double-D Coils

Two wire windings overlap in the shape of two D's (one reversed). The characteristics of a Double-D coil are stability (especially in heavily mineralised ground), good depth and sensitivity, and a very thorough search pattern.

Electromagnetic Field

Commonly called the 'signal from the coil'. An electromagnetic field is generated within the wire windings of the search coil and this field is pulsed or sent into the ground. The presence of a metal target in the ground will disturb the pattern of this field and this disturbance is sensed by the receive system of the detector and indicated to the operator by an audible 'beep'.

False Signals

These sound similar to target signals but are caused by other factors. Common causes for false signals are incorrect Ground Balance, hot rocks, signals caused by knocking the coil on obstacles, etc. With experience, the operator will learn methods to minimise false signals and to hear subtle differences between target signals and false signals.

Ferrous Metals

Metals composed of or containing iron. A ferrous item will be attracted to a magnet and is predominantly, or completely, made of iron or steel.

Ground Balance

The ability of the metal detector to compensate for the effects of ground mineralisation. The GPX-4500 has 'automatic Ground Balance'. When Ground Balance is used in the Tracking setting it continually compensates for changes in the ground mineralisation.

Halo Effect

After a metal object has remained undisturbed in the soil for a considerable amount of time a diffusion occurs around the object. This has the effect of the object appearing to the detector to be a larger size.

Hot Rock

An individual rock which has a high degree of mineralisation in comparison to the surrounding ground around it. Due to this difference the detector does not have the opportunity to Ground Balance to the individual hot rock so therefore gives a false signal. The signal will diminish rapidly by increasing the coil height above the hot rock.

Interference

Electricity or radio waves in the area being detected can cause instability or chattering of the Threshold. Interference commonly occurs due to power lines, underground cables, radar, other detectors or climatic conditions like thunderstorms.

Mineralisation

Most ground contains some minerals, which can cause false ground signals to be detected. Heavily mineralised ground requires different detector processing than does neutral or lightly mineralised ground. Ground containing heavy salt concentrations require entirely different processing again.

Monoloop Coils

Monoloop coils are the style of coil where the multiple strands of wire are wound in a single loop around the circumference of the coil. The field of search of Monoloop coils tends to be cone shaped. They provide greater depth and sensitivity compared to a Double-D coil of equivalent size in low-medium mineralisation.

Non-Ferrous Metals

Metals which do not contain significant levels of iron. Non-magnetic metals such as Gold, Silver, Copper, Brass, Lead or Aluminium.

Pinpoint

The method for determining the precise location of a target prior to digging. Pinpointing uses the design of the search coil windings to determine the exact position of the detected target.

Rx (Receive)

Refers to the response, or electromagnetic field, which is received back by the coil and is used by the control box circuitry to detect a metal item in the ground.

Salt Mineralisation

Salt content in the ground causes a negative (-) response rather than the positive (+) response of laterite soils.

A large salt content in the ground will have a different effect on the detector than other types of mineralisation. Therefore the detector needs to use different filtering techniques to overcome this effect.

Search Coil

The search coil is the circular plate which is swept across the ground surface during detecting. It transmits electromagnetic signals into the ground and receives the response.

Search Pattern

The search pattern is the area of ground underneath the coil which is being scanned. Depending on the style of coil (Double-D or Monoloop) and the Coil/Rx setting being used (Double-D/Monoloop/Cancel), different coils will have a different shaped area being covered by each sweep.

Threshold

The continuous audible level of sound emitted by the detector is referred to as the Threshold. Threshold can be set anywhere between silent and loud; but a soft audible level is normally suggested.

Target Signal

This is a change in the tone (pitch) and volume of the Threshold when a target is detected and not discriminated (rejected).

Tracking

The function of automatic Ground Balance where the detector makes continuous adjustments to the Ground Balance to compensate for changes in the mineralisation of the ground.

Tx (Transmit)

This refers to the transmit signals or electromagnetic pulses, sent into the ground by the coil.

Taking Care of Your Detector

(Taking Care of your Battery, pg. 21)

The GPX-4500 is a high quality electronic instrument. Take care of your detector in the following way:

The control box is water resistant but not waterproof. Keep all electrical connectors clean and dry.

The coil may be used in light rain but take care not to immerse it in water.

The control box and coil should not come into contact with petrol or other oil-based liquids.

Regularly remove loose dirt and dust from the control box using a dry paint brush. Clean the detector shaft and coil with a damp cloth using a mild soap detergent. Do not use solvents.

The coil housing will eventually wear through if you scrub the ground with it while searching. Use of a replaceable skid plate will help to protect your coil. Regularly replace such items as coil washers and skidplates to increase the life of your detector.

To prevent dirt entering between the coil and the skidplate, silk tape (e.g. Leukosilk®) which is available from chemists, may be used. The use of some other carbon based tapes, e.g. insulation tape, may result in some loss of sensitivity.

Do not expose the detector to high temperatures or leave it in the sun for longer than is necessary. Shading will help protect it. Do not leave the detector in a closed vehicle, especially in the sun.

Do not open the control box as this will void your warranty. All control box, battery and coil repairs should be sent back to Minelab or a Minelab authorised repairer.

Technical Specifications

Detector

Transmission	Bi-Level Pulse Induction
Technology	MPS, DVT and SETA
Coil (Standard)	11" Round Double-D
Audio Output	6.35mm (¼") headphone/speaker socket Headphones supplied
LCD	64x128 pixels Transflective, white backlight
Length	Extended: 1300mm (51.2") Unextended: 1100mm (43.3")
Weight Including 11" Coil, (Excluding Battery and Accessories)	2.4kg (5.3lbs)
Operating temperature range	0°C to 45°C (32°F to 113°F)
Storage temperature range	-20°C to +65°C (-4°F to +149°F)

Battery

Type	Lithium Ion
Output Voltage	7.4VDC, 8.4V DC when fully charged. Max discharge current is 1A
Capacity	9.2Ah
Input (Charge)	12-24V DC / 2-3A
Weight	780g (1.72lbs)
Operating temperature range	0°C to 45°C (32°F to 113°F)
Storage temperature range	-5°C to 65°C max, preferred: 5°C to 25°C. (23°F to 149°F max, preferred: 4°F to 77°F)
Battery charge temperature range:	0°C to 45°C (32°F to 113°F)

<i>Main Menu:</i>	<i>Range:</i>	<i>User Preferences:</i>		
Backlight	Off, 1–8			
Volume Limit	1–20			
GB Type	General Specific GB Off			
Special	Salt-Coarse Sens Extra Sens Smooth Sharp			
Manual Tune	0–255			
<i>Mode Name:</i>				
Motion	Very Slow Slow Medium Fast			
Rx Gain	1–15			
Audio Type	Quiet Normal Deep Boost			
Audio Tone	1–100			
Stabilizer	1–20			
Signal	1–20			
Target Volume	1–20			
Response	Normal, Inverted			
Tracking	Slow Medium Fast			
Iron Reject	Off (All Metal) 1–10			

<i>Main Menu:</i>	<i>Range:</i>	<i>User Preferences:</i>		
Backlight	Off, 1–8			
Volume Limit	1–20			
GB Type	General Specific GB Off			
Special	Salt-Coarse Sens Extra Sens Smooth Sharp			
Manual Tune	0–255			
<i>Mode Name:</i>				
Motion	Very Slow Slow Medium Fast			
Rx Gain	1–15			
Audio Type	Quiet Normal Deep Boost			
Audio Tone	1–100			
Stabilizer	1–20			
Signal	1–20			
Target Volume	1–20			
Response	Normal, Inverted			
Tracking	Slow Medium Fast			
Iron Reject	Off (All Metal) 1–10			

Service Repair Form

Today's Date

Detector / Model

Serial Number

Purchased From

Purchase Date

Part(s) Sent

Owner's Name

Address

Telephone () Day

Home

Mobile

Fax ()

Email

Description of Fault

Please explain how we can replicate the problem in order to repair your detector.

cut out or photocopy

